

Report Number 122412-1

Issued: December 24, 2012

Revised:

**A Cooperative Measurement Survey and Analysis of
Low Frequency and Infrasound at the Shirley Wind Farm in
Brown County, Wisconsin**



Prepared Cooperatively By:

Channel Islands Acoustics, Camarillo, CA

Principal: Dr. Bruce Walker

Hessler Associates, Inc., Haymarket, VA

Principals: George F. and David M. Hessler

Rand Acoustics, Brunswick, ME

Principal: Robert Rand

Schomer and Associates, Inc., Champaign, IL

Principal: Dr. Paul Schomer

1.0_Introduction

Clean Wisconsin is a nonprofit environmental advocacy organization that works to protect Wisconsin's air and water and to promote clean energy. As such, the organization is generally supportive of wind projects. Clean Wisconsin was retained by the Wisconsin Public Service Commission (PSC) to provide an independent review of a proposed wind farm called the Highlands Project to be located in St. Croix County, WI (WI PSC Docket 2535-CE-100). Clean Wisconsin in turn retained Hessler Associates, Inc. (HAI) to provide technical assistance.

During the course of the hearings, attorneys representing groups opposed to the Highlands project, presented witnesses that lived near or within the Shirley Wind project in Brown County, WI. The Shirley wind project is made up of eight Nordex100 wind turbines that is one of the turbine models being considered for the Highlands projects. These witnesses testified that they and their children have suffered severe adverse health effects to the point that they have abandoned their homes at Shirley. They attribute their problems to arrival of the wind turbines. David Hessler, while testifying for Clean Wisconsin, suggested a sound measurement survey be made at the Shirley project to investigate low frequency noise (LFN) and infrasound (0-20 Hz) in particular.

Partial funding was authorized by the PSC to conduct a survey at Shirley and permission for home entry was granted by the three homeowners. The proposed test plan called for the wind farm owner, Duke Power, to cooperate fully in supplying operational data and by turning off the units for short intervals so the true ON/OFF impact of turbine emissions could be documented. Duke Power declined this request due to the cost burden of lost generation, and the homeowners withdrew their permission at the last moment because no invited experts on their behalf were available to attend the survey.

Clean Wisconsin, their consultants and attorneys for other groups all cooperated and persisted and the survey was rescheduled for December 4 thru 7, 2012. Four acoustical consulting firms would cooperate and jointly conduct and/or observe the survey. Channel Islands Acoustics (ChIA) has derived modest income while Hessler Associates has derived significant income from wind turbine development projects. Rand Acoustics is almost exclusively retained by opponents of wind projects. Schomer and Associates have worked about equally for both proponents and opponents of wind turbine projects. However, all of the firms are pro-wind if proper siting limits for noise are considered in the project design.

The measurement survey was conducted on schedule and this report is organized to include four Appendices A thru D where each firm submitted on their own letterhead a report summarizing their findings. Based on this body of work, a consensus is formed where possible to report or opine on the following:

- Measured LFN and infrasound documentation
- Observations of the five investigators on the perception of LFN and infrasound both outside and inside the three residences.
- Observations of the five investigators on any health effects suffered during and after the 3 to 4 day exposure.
- Recommendations with two choices to the PSC for the proposed Highlands project
- Recommendations to the PSC for the existing Shirley project

2.0_Testing Objectives

Bruce Walker employed a custom designed multi-channel data acquisition system to measure sound pressure in the time domain at a sampling rate of 24,000/second where all is collected under the same clock. The system is calibrated accurate from 0.1 Hz thru 10,000 Hz. At each residence, channels were cabled to an outside wind-speed anemometer and a microphone mounted on a ground plane covered with a 3 inch hemispherical wind screen that in turn was covered with an 18 inch diameter and 2 inch thick foam hemispherical dome (foam dome). Other channels inside each residence were in various rooms including basements, living or great rooms, office/study, kitchens and bedrooms. The objective of this set-up was to gather sufficient data for applying advanced signal processing techniques. See Appendix A for a Summary of this testing.

George and David Hessler employed four off-the-shelf type 1 precision sound level meter/frequency analyzers with a rated accuracy of +/- 1 dB from 5 Hz to 10,000 Hz. Two of the meters were used as continuous monitors to record statistical metrics for every 10 minute interval over the 3 day period. One location on property with permission was relatively close (200m) to a wind turbine but remote from the local road network to serve as an indicator of wind turbine load, ON/OFF times and a crude measure of high elevation wind speed. See cover photo. This was to compensate for lack of Duke Power's cooperation. The other logging meter was employed at residence R2, the residence with the closest turbines. The other two meters were used to simultaneously measure outside and inside each residence for a late night and early morning period to assess the spectral data. See Appendix B for a Summary of this testing.

Robert Rand observed measurements and documented neighbor reports and unusual negative health effects including nausea, dizziness and headache. He used a highly accurate seismometer to detect infrasonic pressure modulations from wind turbine to residence. See Appendix C for Rob's Summary.

Paul Schomer used a frequency spectrum analyzer as an oscilloscope wired into Bruce's system to detect in real time any interesting occurrences. Paul mainly circulated around observing results and questioning and suggesting measurement points and techniques. See Appendix D for Paul's Summary.

Measurements were made at three unoccupied residences labeled R1, R2 and R3 on Figure 2.1. The figure shows only the five closest wind turbines and other measurement locations. All in all, the investigators worked very well together and there is no question or dispute whatsoever about measurement systems or technique and competencies of personnel. Of course, conclusions from the data could differ. Mr. M. Hankard, acoustical consultant for the Highland and Shirley projects, accompanied, assisted and observed the investigators on Wednesday, 12/5.



Figure 2.1: Aerial view showing sound survey locations

The four firms wish to thank and acknowledge the extraordinary cooperation given to us by the residence owners and various attorneys.

3.0_Investgator Observations

Observations from the five investigators are tabulated below: It should be noted the investigators had a relatively brief exposure compared to 24/7 occupation.

AUDIBILITY OUTSIDE RESIDENCES	
	<i>Observations</i>
Bruce Walker	Could detect wind turbine noise at R1, easily at R2, but not at all at R3
George Hessler	Could detect wind turbine noise at R1, easily at R2, but not at all at R3
David Hessler	Could detect wind turbine noise at R1, easily at R2, but not at all at R3
Robert Rand	Could detect wind turbine noise at all residences
Paul Schomer	Not sure at R1 but could detect wind turbine noise at R2, not at all at R3
AUDIBILITY INSIDE RESIDENCES	
	<i>Observations</i>
Bruce Walker	Could not detect wind turbine noise inside any home
George Hessler	Could not detect wind turbine noise inside any home
David Hessler	Could faintly detect wind turbine noise in residence R2
Robert Rand	Could detect wind turbine noise inside all three homes
Paul Schomer	Could not detect wind turbine noise inside any home
EXPERIENCED HEALTH EFFECTS	
	<i>Observations</i>
Bruce Walker	No effects during or after testing
George Hessler	No effects during or after testing
David Hessler	No effects during or after testing
Robert Rand	Reported ill effects (headache and/or nausea while testing and severe effects for 3+ days after testing)
Paul Schomer	No effects during or after testing

4.0_Conclusions

This cooperative effort has made a good start in quantifying low frequency and infrasound from wind turbines.

Unequivocal measurements at the closest residence R2 are detailed herein showing that wind turbine noise is present outside and inside the residence. Any mechanical device has a unique frequency spectrum, and a wind turbine is simply a very very large fan and the blade passing frequency is easily calculated by $\text{RPM}/60 \times \text{the number of blades}$, and for this case; $14 \text{ RPM}/60 \times 3 = 0.7 \text{ Hz}$. The next six harmonics are 1.4, 2.1, 2.8, 3.5, 4.2 & 4.9 Hz and are clearly evident on the attached graph below. Note also there is higher infrasound and LFN inside the residence in the range of 15 to 30 Hz that is attributable to the natural flexibility of typical home construction walls. This higher frequency reduces in the basement where the propagation path is through the walls plus floor construction but the tones do not reduce appreciably.

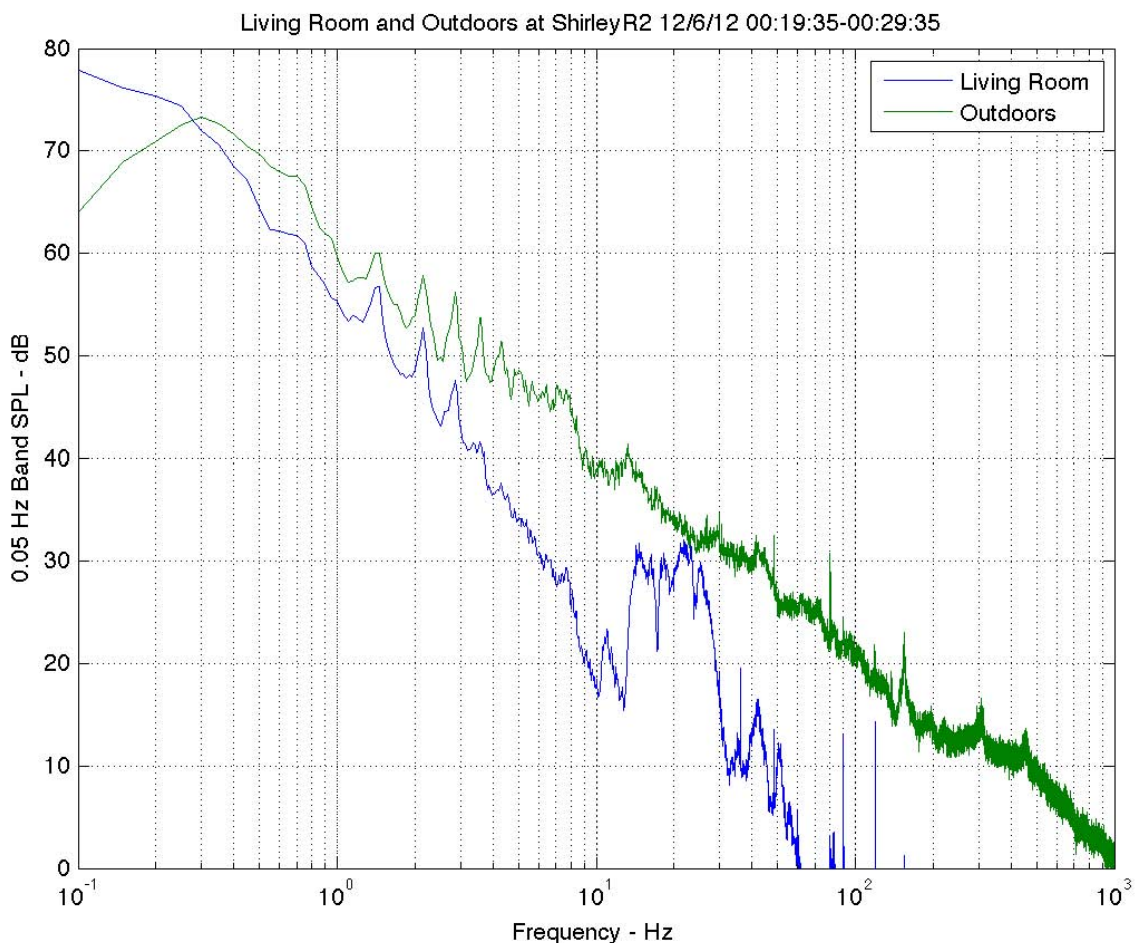

Measurements at the other residences R1 and R3 do not show this same result because the increased distance reduced periodic turbine noise closer to the background and/or turbine loads at the time of these measurements resulted in reduced acoustical emission. Future testing should be sufficiently extensive to cover overlapping turbine conditions to determine the decay rate with distance for this ultra low frequency range, or the magnitude of measurable wind turbine noise with distance.

The critical questions are what physical effects do these low frequencies have on residents and what LFN limits, if any, should be imposed on wind turbine projects. The reported response at residence R2 by the wife and their child was extremely adverse while the husband suffered no ill effects whatsoever, illustrating the complexity of the issue. The family moved far away for a solution.

A most interesting study in 1986 by the Navy reveals that physical vibration of pilots in flight simulators induced motion sickness when the vibration frequency was in the range of 0.05 to 0.9 Hz with the maximum (worst) effect being at about 0.2 Hz, not too far from the blade passing frequency of future large wind turbines. If one makes the leap from physical vibration of the body to physical vibration of the media the body is in, it suggests adverse response to wind turbines is an acceleration or vibration problem in the very low frequency region.

The four investigating firms are of the opinion that enough evidence and hypotheses have been given herein to classify LFN and infrasound as a serious issue, possibly affecting the future of the industry. It should be addressed beyond the present practice of showing that wind turbine levels are magnitudes below the threshold of hearing at low frequencies.

5.0_Recommendations

5.1_General

We recommend additional study on an urgent priority basis, specifically:

- A comprehensive literature search far beyond the search performed here under time constraints.
- A retest at Shirley to determine the decay rate of ultra low frequency wind turbine sound with distance with a more portable system for measuring nearly simultaneously at the three homes and at other locations.
- A Threshold of Perception test with participating and non-participating Shirley residents.

5.2_For the Highlands Project

ChIA and Rand do not have detail knowledge of the Highland project and refrain from specific recommendations. They agree in principle to the conclusions offered herein in Section 4.0.

Hessler Associates has summarized their experience with wind turbines to date in a peer-reviewed Journal¹ and have concluded that adverse impact is minimized if a design goal of 40 dBA (long term average) is maintained at all residences, at least at all non-participating residences. To the best of their knowledge, essentially no annoyance complaints and certainly no severe health effect complaints, as reported at Shirley, have been made known to them for *all* projects designed to this goal.

¹ Hessler G., & David, M., "Recommended noise level design goals and limits at residential receptors for wind turbine developments in the United States", Noise Control Engineering Journal, 59(1), Jan-Feb 2011

Schomer and Associates, using an entirely different approach have concluded that a design goal of 39 dBA is adequate to minimize impact, at least for an audible noise impact. In fact, a co-authored paper² is planned for an upcoming technical conference in Montreal, Canada.

Although there is no explicit limit for LFN and infrasound in these A-weighted sound levels above, the spectral shape of wind turbines is known and the C-A level difference will be well below the normally accepted difference of 15 to 20 dB. It may come to be that this metric is not adequate for wind turbine work but will be used for the time being.

Based on the above, Hessler Associates recommends approval of the application if the following Noise condition is placed on approval:

With the Hessler recommendation, the long-term-average (2 week sample) design goal for sound emissions attributable to the array of wind turbines, exclusive of the background ambient, at all non-participating residences shall be 39.5 dBA or less.

Schomer and Associates recommends that the additional testing listed in 5.3 be done at Shirley on a very expedited basis with required support by Duke Energy prior to making a decision on the Highlands project. It is essential to know whether or not some individuals can perceive the wind turbine operation at R1 or R3. With proper resources and support, these studies could be completed by late February or early March. If a decision cannot be postponed, then Schomer and Associates recommends a criterion level of 33.5 dB. The Navy's prediction of the nauseogenic region (Schomer Figure 6 herein) indicates a 6 dB decrease in the criterion level for a doubling of power such as from 1.25 MW to 2.5 MW.

With the Schomer recommendation, and in the presence of a forced decision, the long-term-average (2 week sample) design goal for sound emissions attributable to the array of wind turbines, exclusive of the background ambient, at all non-participating residences shall be 33.5 dBA or less.

There is one qualifier to this recommendation. The Shirley project is unique to the experience of the two firms in that the Nordex100 turbines are very high rated units (2.5 MW) essentially not included in our past experiences. HAI has completed just one project, ironically named the Highlands project in another state that uses both Nordex 90 and Nordex 100 units in two phases. There is a densely occupied Town located 1700 feet from the closest Nordex 100 turbine. The president and managers of the wind turbine company report "no noise issues at the site".

Imposing a noise limit of less than 45 dBA will increase the buffer distances from turbines to houses or reduce the number of turbines so that the Highlands project will *not* be an exact duplication of the Shirley project. For example, the measured noise level at R2 is approximately 10 dBA higher than the recommendation resulting in a subjective response to audible outside noise as twice as loud. Measured levels at R1 and R3 would comply with the recommendation.

We understand that the recommended goal is lower than the limit of 45 dBA now legislated, and may make the project economically unviable. In this specific case, it seems justified to the two firms to be conservative (one more than the other) to avoid a duplicate project to Shirley at Highlands because there is no technical reason to believe the community response would be different.

² Schomer, P. & Hessler, G., "Criteria for wind-turbine noise immissions", ICA, Montreal, Canada 2013

5.3_For the Shirley Project

The completed testing was extremely helpful and a good start to uncover the cause of such severe adverse impact reported at this site. The issue is complex and relatively new. Such reported adverse response is sparse or non-existent in the peer-reviewed literature. At least one accepted paper at a technical conference³ has been presented. There are also self-published reports on the internet along with much erroneous data based on outdated early wind turbine experience.

A serious literature search and review is needed and is strongly recommended. Paul Schomer, in the brief amount of time for this project analysis, has uncovered some research that *may* provide a probable cause or direction to study for the reported adverse health effects. We could be close to identifying a documented cause for the reported complaints but it involves much more serious impartial effort.

An important finding on this survey was that the cooperation of the wind farm operator is absolutely essential. Wind turbines must be measured both ON and OFF on request to obtain data under nearly identical wind and power conditions to quantify the wind turbine impact which could not be done due to Duke Power's lack of cooperation.

We strongly recommend additional testing at Shirley. The multi-channel simultaneous data acquisition system is normally deployed within a mini-van and can be used to measure immissions at the three residences under the identical or near identical wind and power conditions. In addition, seismic accelerometer and dedicated ear-simulating microphones can be easily accommodated. And, ON/OFF measurements require the cooperation of the operator.

Since the problem may be devoid of audible noise, we also recommend a test as described by Schomer in Appendix D to develop a "Threshold of Perception" for wind turbine emissions.



Bruce Walker



George F. Hessler Jr.



David M. Hessler



Robert Rand



Paul Schomer

³ Ambrose, S. E., Rand, R. W., Krogh, C. M., "Falmouth, Massachusetts wind turbine infrasound and low frequency noise measurements", Proceedings of Inter-Noise 2012, New York, NY, August 19-22.

APPENDIX A
by
CHANNEL ISLANDS ACOUSTICS

Channel Islands Acoustics
676 West Highland Drive
Camarillo, CA 93010
805-484-8000 FAX 805-482-5075
bwalker@channelislandsacoustics.com

Low Frequency Acoustic Measurements at Shirley Wind Park

Bruce Walker, Ph.D., INCE Bd. Cert.

OVERVIEW

Bruce Walker of Channel Islands Acoustics (ChIA) was requested by Hessler Associates to assist in defining low and infrasonic frequency (approximately 0.5 – 100 Hz) sounds at abandoned residences in the environs of Shirley Wind Park near DePere, WI. ChIA has been developing a measurement system that combines extended range microphones and recording equipment with mixed time domain and frequency domain signal processing in an effort to quantify sound levels and waveform properties of very low frequency periodic signals radiated by large wind turbines¹.

The Shirley Wind park consists of eight Nordex turbines with 85 meter hub height and 100 meter rotor diameter. These turbines are distributed over an approximately six square mile area in Brown County, WI as shown in Figure 1. The turbines are of similar in size to those investigated in Ref. 1.



Figure 1. Environs of Shirley Wind Park, Showing Eight Turbines and Three Abandoned Residences Investigated in the Program

The tests included acoustic measurement at multiple locations inside and outside three abandoned residences, at nominal distances and bearings from the three turbines as shown in Table 1, and will be described in greater detail in a subsequent section. Test methodology and schedule were constrained to a testing period December 4-7 and inability to park the turbines to establish a reliable background noise baseline.

Table 1. Distances in feet and Bearing in degrees East of North from Turbines to Tested Residences

Receiver	R1		R2		R3	
Source	Distance	Bearing	Distance	Bearing	Distance	Bearing
WTG1	18300	74	15400	53	12250	31
WTG2	18050	78	14800	57	11300	34
WTG3	6270	82	5290	11	8140	322
WTG4	5070	63	6650	353	10330	319
WTG5	3990	93	4330	343	9020	307
WTG6	3303	72	5810	338	10470	309
WTG7	4870	141	2280	286	8360	282
WTG8	5540	127	1280	322	7110	288

ChIA measurements were conducted at residence R1 (Fairview) on the evening of December 4 and the early afternoon of December 5. Measurements were conducted at residence R2 (Glenmore) during late evening and late night December 5/early morning December 6 and mid-afternoon December 6. Measurements were conducted at residence R3 (Schmidt) during late afternoon December 6 and mid-morning December 7. Times of tests are mean wind speeds are shown in Table 3.

TERMINOLOGY

It is assumed the reader is familiar with commonly encountered acoustical terms and units such as decibel (dB), sound level, sound pressure level, sound power level, spectrum, frequency, hertz (Hz), etc. The following is a brief glossary of terms and units that lay-persons may not be familiar with, but which will be used to describe some of the data analyses in this program.

pascals (Pa) – the standard unit of pressure. The reference sound pressure is 20 microPa. Atmospheric pressure is just over 100,000 Pa. An acoustic signal of 1 Pa rms amplitude has a sound pressure level of 94 dB.

correlation function (CC(τ)) – a time-domain description of the commonality between two signals as a function of the time delay between them. The unit is Pa-squared. The correlation function for a signal and itself is the auto-correlation, and the rms amplitude of the signal is the square-root of the auto-correlation at zero delay. The correlation function between separate signals is the cross-correlation. The peak delay of the cross-correlation time the speed of propagation shows the difference in path length between the two signals if they result from a common

source. The **correlation coefficient** is the cross-correlation function divided by the product of the square roots of the auto-correlation at zero delay.

power spectral density function (PSD) – the average of the squared-magnitude of the frequency spectrum of a time-varying signal, divided by the nominal bandwidth (BW in Hz) of the spectral analysis. The unit is Pa-squared per Hz. Narrow band sound pressure levels in this report are computed in dB as $10 \log(\text{PSD} \times \text{BW}) + 94$.

cross-PSD – the frequency-by-frequency average of the products of the spectra from two signals.

coherence function - a frequency-domain description of the relative commonality between two signals. It is determined as the frequency-by-frequency ratio of the cross-PSD to the product of the square roots of the two PSD's. If a spectral component in two signals results from a common source, the coherence is unity (1) and if the spectral component results from two statistically independent sources, the coherence is zero.

spectrograph – a display of amplitude as color or brightness vs frequency and time.

MEASUREMENT SYSTEM and DATA ACQUISITION

A basic list of the components in the measurement system are shown in Table 2. Serial numbers and calibration certifications are available on request.

Table 2. Basic Components of ChIA Low-Frequency Acoustic Data Acquisition System

Item	Type	Number
Portable Acoustic Analyzer	B&K 2250	2
Low Frequency Microphone	B&K 4193	6
Microphone Preamp	B&K 2639	4
Signal Conditioning Amp	B&K NEXUS 2690-OS4	1
24 Bit Simultaneous ADC	DT9826-16	1
Laptop Computer	Acer	1
Calibrator	B&K 4231	1
Anemometer	NRG Cup & Resolver	1

As deployed in this program, the 4193 microphones with low-frequency extensions, 2639 preamplifiers and NEXUS signal conditioner were placed in three or four rooms of the residences, while a fifth 4193 and a 2250 analyzer was placed in a standard 3-1/2 inch hemisphere wind ball under an 18 inch foam secondary wind screen on a ground board approximately 50 ft from the residence in the direction of wind turbines. The sixth 4193 and second 2250 were held in reserve and ultimately deployed at R3 on December 7. Full system throughput calibration was run for all channels each day and after each equipment relocation.

Measurement data was collected with simultaneous in 10-minute blocks at sampling rate 24 kHz as shown in the Test Log, Table 3. The signal conditioning amplifiers were set for range 0.1 Hz to 10 kHz. Amplifier sensitivities were set to allow sound pressures up to 10 Pa (114 dB) to be accepted without system overload. The output of the NRG cup anemometer/resolver was recorded on a seventh channel of the

recording system. Acoustic signals, wind speed signals, set-up conditions and microphone location descriptions were stored in Matlab mat files and portions of the recorded signal were displayed for signal quality examination.

Table 3. Summary Test Log

Channel	1	2	3	4	5	6	7	Date	Start Time
Location R1	Study Desk	MBR Bedhead	Kitchen Counter	Outside Wall	Outside Ground Board	No Signal	Wind		
04T182504							2.3	12/4/12	20:25:04
04T184332							2.2	12/4/12	20:43:32
04T191533							3.2	12/4/12	21:15:33
04T192808							2.8	12/4/12	21:28:08
05T102032							1.2	12/5/12	12:20:32
05T110121							1.4	12/5/12	13:10:21
05T112110							1.5	12/5/12	13:21:10
Location R2	Living Room	Upstairs BR	Behind Kitchen	Basement	Outside Ground Board	No Signal	Wind		
05T204657								12/5/12	22:46:57
05T212420								12/5/12	23:24:20
05T213611							2.3	12/5/12	23:36:11
05T221935							3.0	12/6/12	0:19:35
05T231754							3.2	12/6/12	1:17:54
06T001413							3.3	12/6/12	2:14:13
06T120621							2.1	12/6/12	14:06:21
06T122547							1.7	12/6/12	14:25:47
Location R3	Family Room	Upstairs BR	Living Room	Basement	Outside Ground Board	No Signal	Wind		
06T135713							2.8	12/6/12	15:57:13
06T142857							2.4	12/6/12	16:28:57
Location R3	Family Room	Upstairs BR	Living Room	No Signal	Outside Ground Board	Isotron 86 on K Island	Wind		
07T092024							1.1	12/7/12	11:20:24
Location R3	Family Room	Upstairs BR	No Signal	Basement	Outside Ground Board	Living Room 2250	Wind		
07T094616							0.9	12/7/12	11:46:16
07T100232							1.1	12/7/12	12:02:32
	Note Blue = Chevy SUV Front Seat								
	Note Red = Problem Data								
	Note Gray = Channel Not Used								

DATA ANALYSIS

For each ten-minute data block, the following computed values were obtained and stored:

1. For each data channel, the time history of the signal, phaseless band pass filtered from 0.5 to 100 Hz, the time histories of Leq100ms for A, C, Z, G and 0.5-100 Hz bandpass filtering.
2. For each data channel, the 0.1 Hz narrow band and one-third octave frequency spectra covering the range 0.5 to 1,000 Hz, and the coherence function between the outdoor microphone and each indoor microphone.
3. For each data channel, the auto-correlation function and the cross correlation function from the outdoor microphone to each indoor microphone for the delay range -10 to +10 seconds.

It was observed in the time history plots that “high intensity” regions in the indoor and outdoor microphone channels were not necessarily aligned in time, possibly indicating that indoor noise sometimes resulted from sources other than those affecting the outdoor microphone. To study this in additional detail, each 10-minute data block was analyzed in 20-second sub-blocks for narrow-band frequency spectrum, cross-spectrum with the outdoor microphone and coherence with the outdoor microphone.

Following this, the spectrum with the most distinct representation of turbine blade passage pulsation was identified. From the Blade Passage harmonic series noted for this spectrum, waveforms were synthesized assuming two sets of phase relationships. In the first, the harmonics were arranged as sine waves with zero phase. In the second, they were arranged as cosine waves with zero phase. The former produces a composite wave with maximum wavefront slope while the latter produces a composite wave with maximum peak-to-rms ratio (crest factor).

RESULTS EXAMPLES

The test produced a large compendium of testing results, which, it is hoped, can be correlated with turbine operating conditions from data yet to be received. Mean local wind speeds for all blocks are shown (meters per second) in Table 3. Illustrative examples showing disparities among the three residences are shown in the following graphs. The full set of data is available for review.

Figure 2 shows a sample of raw data collected during windy conditions at Residence R2. Note that apparently wind-driven very low frequency pressure fluctuations are well synchronized and nearly equal in amplitude at four disparate locations within the home.

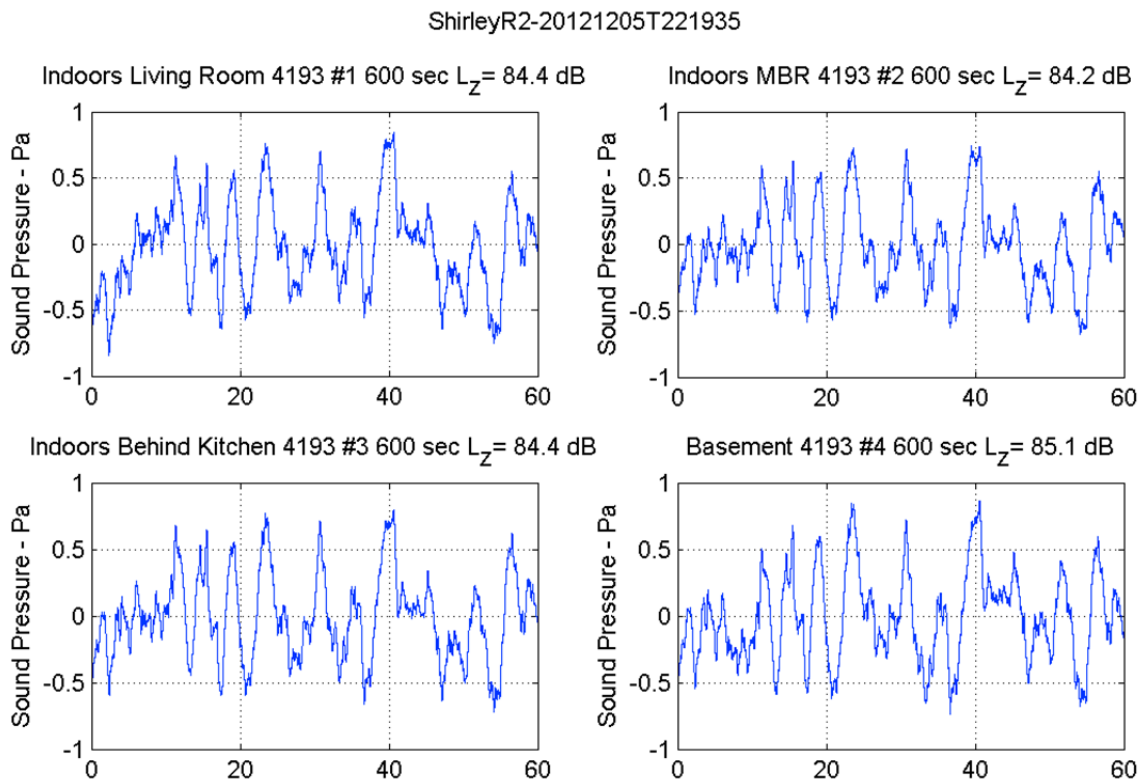

Figure 2. First Minute of Raw Data Collected at R2 On Dec 6 Starting 00:19:35. Note very low frequency fluctuations are nearly equal at four locations.

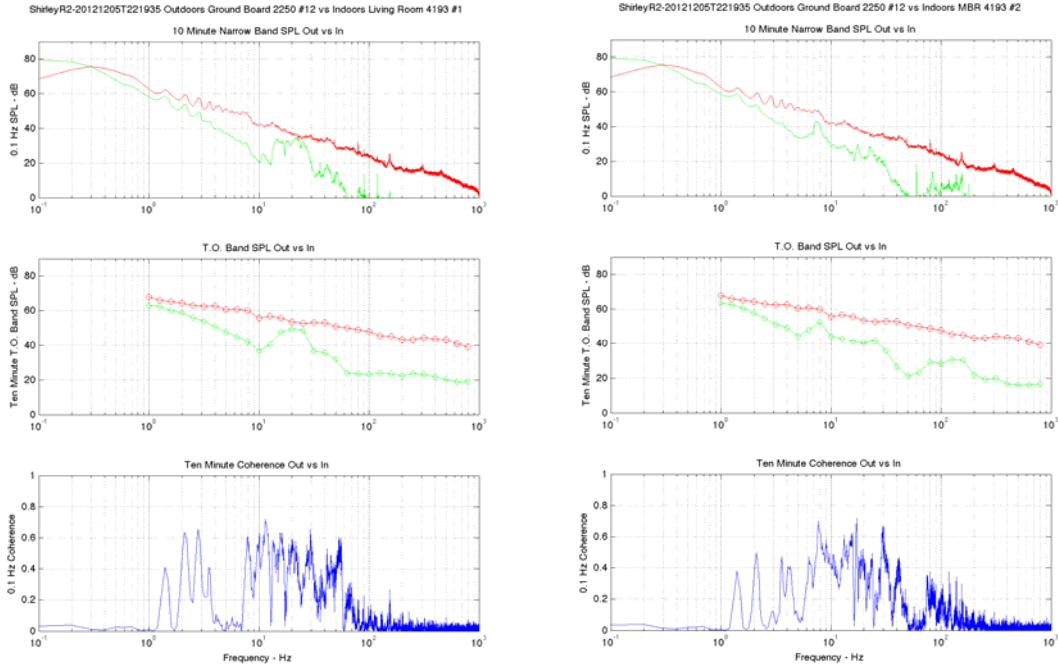

Figure 3. Low Frequency (0.1-1,000 Hz) Spectra and Coherence from Two Rooms in R2 measured 12/6/12 starting 00:19:35 showing differences in detail and well correlated low-order blade-pass harmonics. Red curve is measured outdoors between turbines and home.

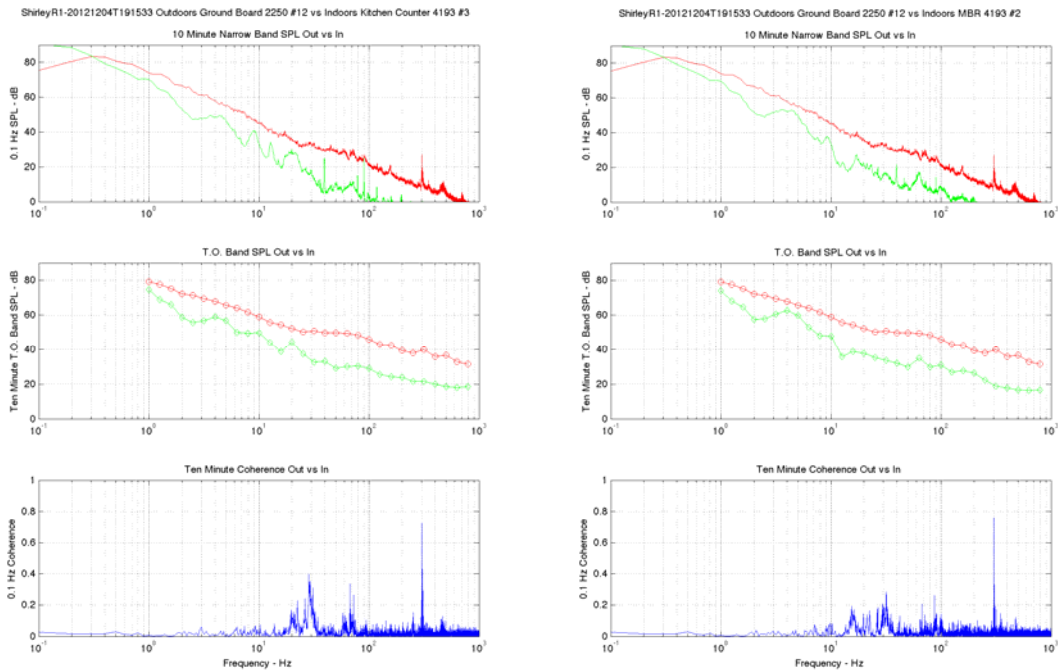

Figure 4. Low Frequency (0.1-1,000 Hz) Spectra and Coherence from Two Rooms in R1 measured 12/4/12 starting 21:15:33 showing differences in detail and poorly correlated low-order blade-pass harmonics. Red curve is measured outdoors between turbines and home.

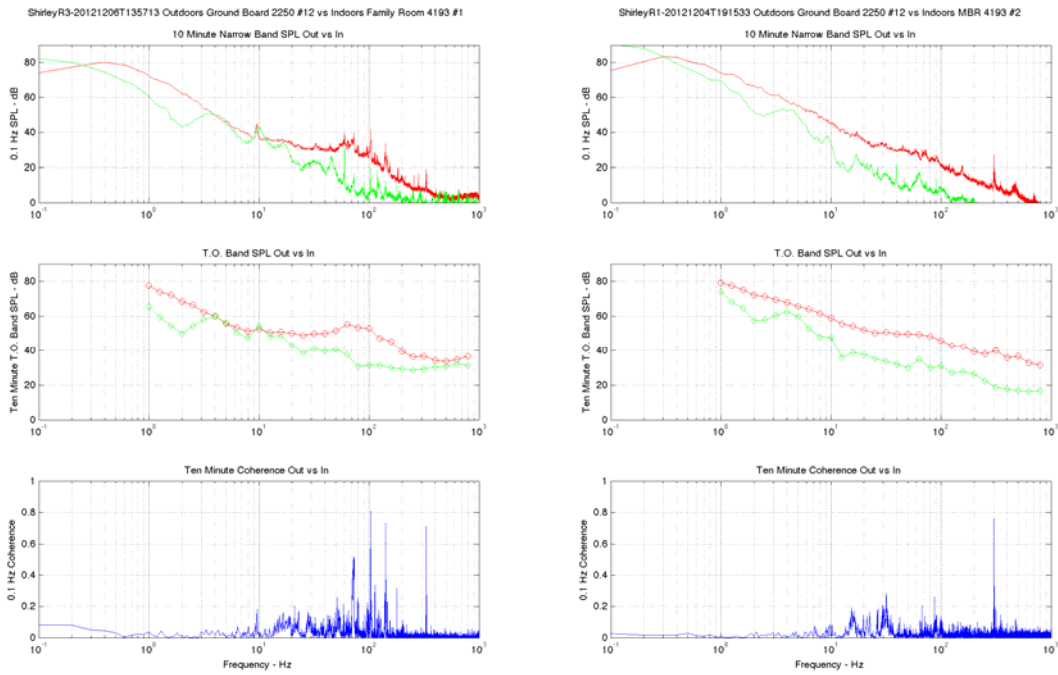

Figure 5. Low Frequency (0.1-1,000 Hz) Spectra and Coherence from Two Rooms in R3 measured 12/6/12 starting 15:57:13 showing differences in detail, poorly correlated low-order blade-pass harmonics and well correlated tones from passing vehicle exhausts. Red curve is measured outdoors between turbines and home.

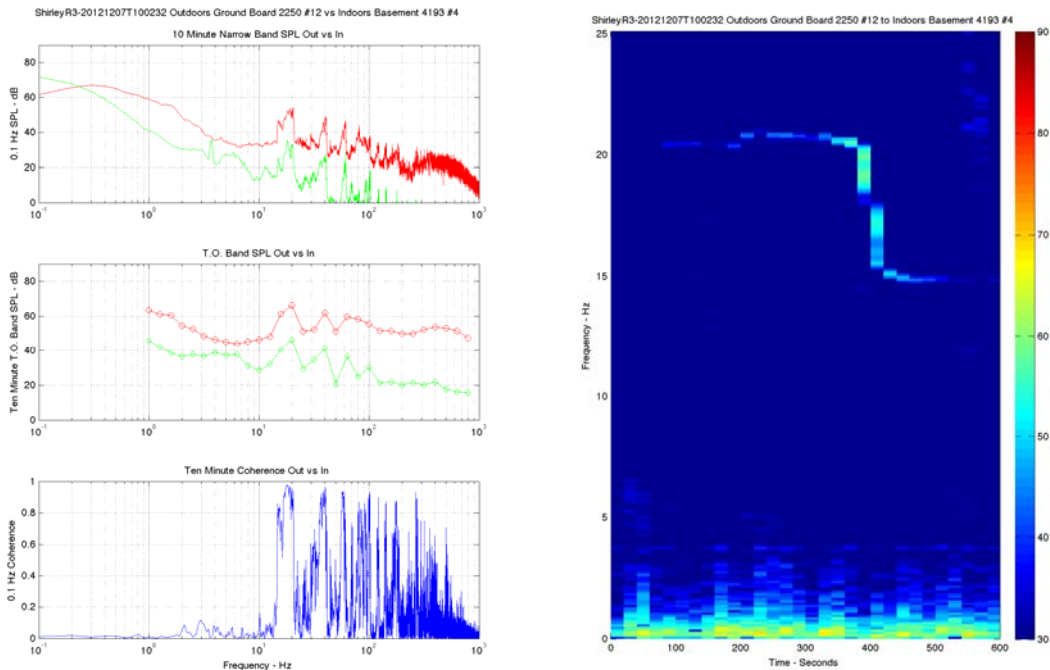

Figure 6. Low Frequency Spectra and Outdoor-Indoor Cross Spectrograph in Basement of R3 with Helicopter flyover. Note Doppler shift of rotor tone from 20.5 Hz on approach to 15 Hz receding. Also note high coherence of the helicopter rotor blade harmonics. Note very low coherence of turbine blade frequencies below 10 Hz, suggesting most of the infrasound is general atmospheric pressure fluctuation and wind force on the residence.

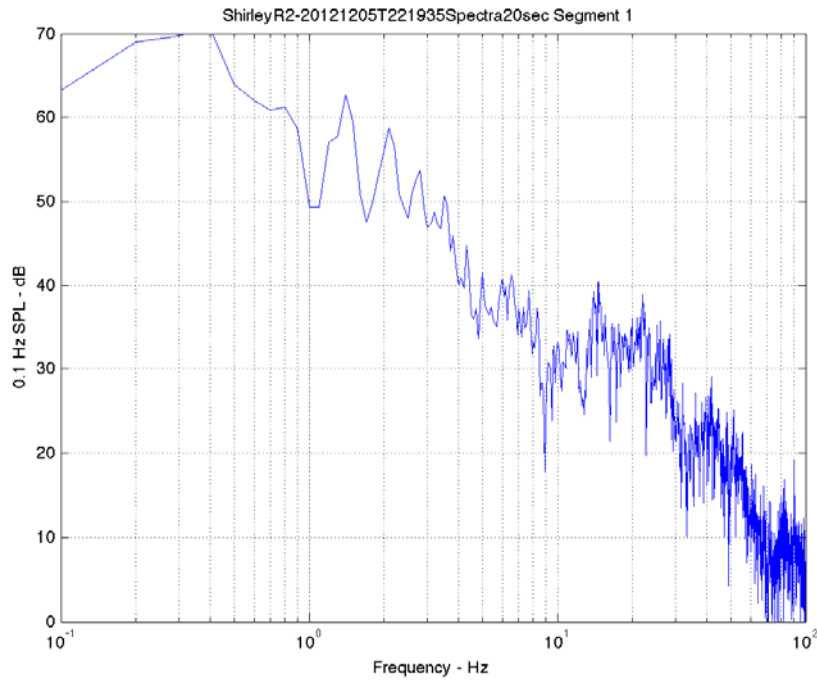

Figure 7. Short (20 sec) duration spectrum with best defined turbine blade harmonics, multiples of 0.7 Hz. Overall SPL of the Blade Pass Signal is 70 dB.

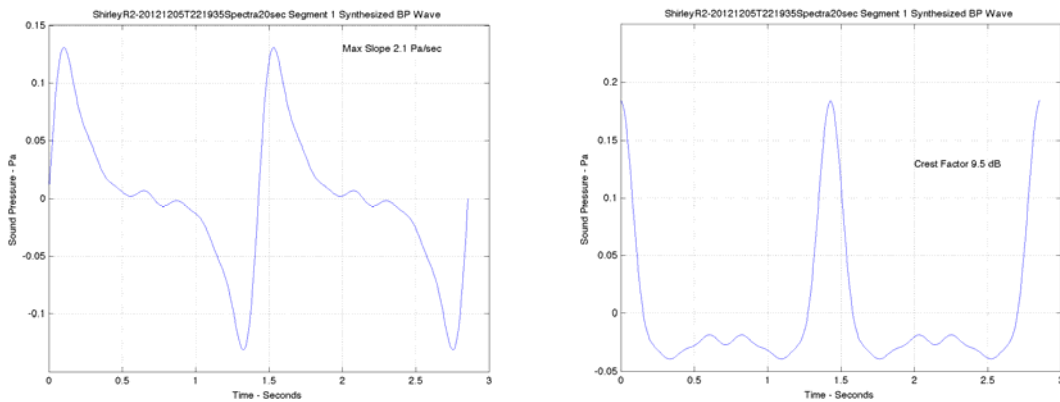

Figure 8. Turbine blade-pass waveforms synthesized from the harmonic series shown in Figure 7. Peak-to-peak SPL of the left-hand, more probable signal is about 82 dB.

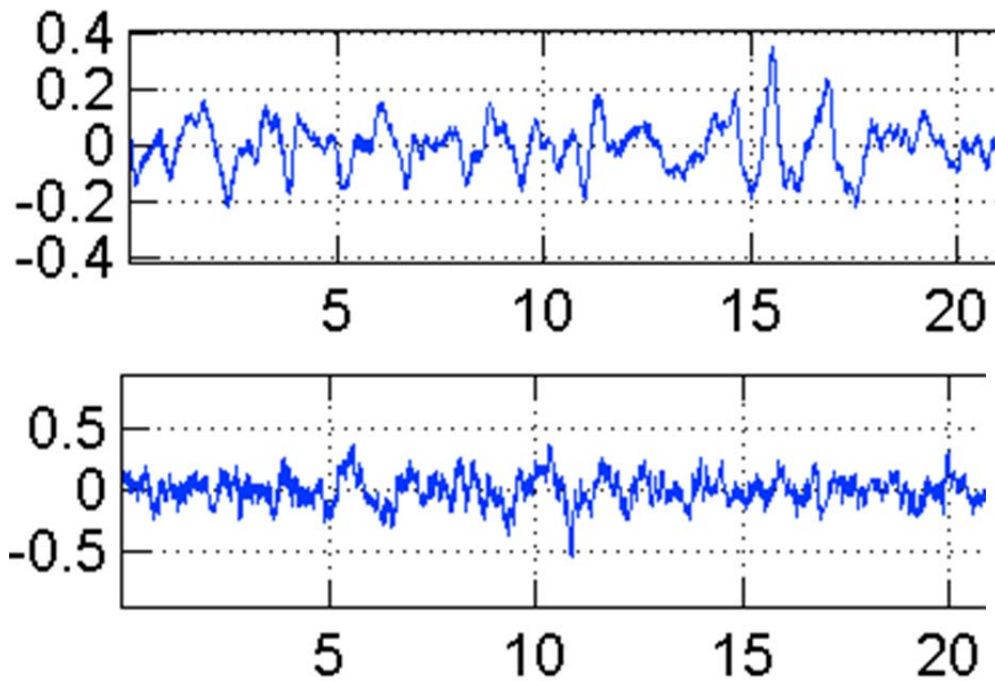

Figure 9. 0.5 Hz Phaseless High-Pass Filtered Waves Indoors (upper) and Outdoors at R2, Corresponding to Spectrum of Figure 7. Note repetitive waves indoors, similar to left-hand synthesized example. Note transient event indoors at 15.5 seconds unrelated to outside noise.

A summary of statistical sound levels for each test is shown in Table 4. Note that the high frequency noise floor of the low-frequency microphones used indoors limits the A-weighted results to 29-30 dB minimum. The cells marked in red were affected by system overload or other problems and should be discounted. The cells marked in gold are for a seismic accelerometer mounted on the Kitchen island of R3 and are not calibrated except that 94 dB is approximately 1 m/sec². The cells marked in teal are taken on the front seat of the Mini-SUV parked outside R2. All others are normal measurements as shown in the Log, Table 3.

Table 4. Statistical Sound Levels for All 10-minute Tests

Shirley ChIA	Weight Channel	LA					LC					LZ					LG					L 0.5-100				
		1	2	3	4	5	1	2	3	4	5	1	2	3	4	5	1	2	3	4	5	1	2	3	4	5
R1	L1	36.9	32.3	42.4	54.0	43.6	52.5	49.2	53.0	72.0	62.5	93.7	93.5	93.8	111.9	93.4	67.5	67.1	68.3	87.5	72.4	80.7	79.8	80.1	94.9	90.2
	L10	33.7	30.5	34.6	37.7	42.4	50.7	42.9	46.2	60.0	56.2	89.5	89.1	89.4	94.4	86.1	63.9	63.0	64.1	73.0	66.5	74.7	73.7	73.8	82.4	82.1
	L50	33.2	30.1	30.3	32.3	41.5	48.9	39.8	42.7	48.5	53.9	80.6	80.0	80.5	84.7	75.7	58.6	55.7	58.3	62.0	61.6	66.1	65.2	65.2	71.0	70.9
	L90	32.6	29.8	29.6	31.0	41.0	47.2	37.5	40.0	45.5	52.1	67.7	67.0	67.2	71.3	64.5	53.9	49.7	53.2	55.3	57.3	58.5	56.3	56.5	59.7	62.0
	Leq	35.9	33.7	34.1	34.0	41.7	49.2	41.2	44.4	49.9	55.1	85.0	84.6	85.0	102.6	82.8	60.4	58.9	60.6	69.4	64.2	70.8	69.8	69.9	98.0	79.2
R1	L1	36.1	32.6	34.8	66.9	49.6	53.2	51.1	50.8	85.3	68.4	104.1	104.0	104.3	112.9	102.6	77.3	77.2	77.5	92.7	79.2	79.7	79.7	90.0	104.1	97.4
	L10	34.0	31.2	30.7	54.8	45.3	51.2	47.2	47.1	76.3	59.8	98.6	98.5	98.8	107.3	94.0	71.9	71.7	72.1	85.7	71.6	84.1	83.3	83.6	96.7	89.6
	L50	33.5	30.3	29.8	44.7	42.2	49.5	42.7	43.5	64.1	55.8	89.8	89.7	90.0	99.0	84.0	64.1	63.3	64.0	77.6	64.7	75.0	74.3	74.4	87.3	78.7
	L90	33.2	29.9	29.4	41.8	41.4	47.9	39.5	40.6	57.6	53.5	76.4	76.2	76.6	86.2	71.5	57.3	54.1	56.2	69.7	59.6	64.8	63.8	63.9	76.7	67.6
	Leq	35.9	33.7	34.1	54.0	43.5	50.7	46.4	47.0	73.1	58.6	94.6	94.4	94.7	103.2	90.8	68.2	67.9	68.4	82.3	69.2	80.2	79.4	79.6	93.1	86.0
R1	L1	34.9	32.4	34.4	64.2	51.9	50.4	48.0	48.2	83.5	66.2	100.6	100.4	100.7	111.5	98.4	73.7	73.6	74.0	91.1	75.6	86.4	85.4	85.7	102.0	94.1
	L10	32.5	30.6	30.4	52.6	43.8	48.7	44.5	44.8	75.1	58.8	95.9	95.7	96.0	106.0	91.3	69.1	69.0	69.3	84.4	68.6	69.1	80.0	80.1	94.8	86.4
	L50	32.2	30.1	29.7	43.2	41.7	47.4	41.0	41.5	62.4	54.7	87.7	87.6	87.8	96.7	80.9	61.6	61.2	61.9	75.8	63.0	72.1	71.5	71.5	85.0	75.5
	L90	32.0	29.8	29.0	40.8	41.0	46.2	38.2	38.4	56.4	52.6	74.1	74.1	74.2	83.6	68.6	53.0	52.3	54.5	67.0	58.3	61.5	61.1	60.8	73.0	64.5
	Leq	32.7	30.3	30.0	51.9	43.2	47.6	42.0	42.4	71.6	57.1	91.6	91.4	91.7	101.7	87.6	65.0	64.8	65.3	80.8	66.2	76.7	75.9	76.0	91.1	82.8
R1	L1	36.5	36.8	47.5	56.9	44.4	56.9	57.5	63.4	72.7	59.9	96.6	96.2	96.4	92.9	87.4	71.3	71.4	76.8	73.9	68.8	83.9	83.0	83.4	76.0	82.5
	L10	31.9	31.2	39.1	38.7	41.0	48.4	45.8	50.2	60.9	57.8	90.5	90.1	90.5	85.0	78.9	65.2	64.8	67.0	70.2	66.2	76.8	76.0	76.3	67.5	71.7
	L50	31.3	30.1	30.8	37.4	40.4	46.0	41.5	44.7	58.6	55.8	79.8	79.3	80.1	75.5	68.2	57.8	56.4	60.2	66.5	62.2	65.2	64.7	64.8	64.1	63.0
	L90	31.0	29.7	29.3	36.7	40.0	44.2	38.9	40.9	56.3	53.7	67.2	65.8	66.2	65.8	60.9	52.8	50.6	55.2	62.3	57.8	55.6	54.8	55.6	61.1	59.0
	Leq	32.1	31.0	37.0	53.4	40.8	47.6	45.8	51.0	70.0	56.1	86.1	85.8	86.2	81.8	75.9	61.7	61.5	65.8	69.4	63.2	73.2	72.3	72.6	71.5	70.4
R1	L1	46.2	30.8	35.0	41.3	42.1	56.0	45.3	49.1	63.0	60.2	83.5	82.6	83.6	89.6	89.9	66.6	58.2	63.0	73.1	69.6	72.6	69.2	69.4	72.1	84.4
	L10	37.3	30.2	30.7	39.7	41.0	53.5	43.1	46.6	61.3	58.4	79.4	78.2	78.7	81.9	82.9	60.6	55.5	60.3	70.6	67.0	64.7	63.0	62.8	67.9	76.5
	L50	36.3	29.9	29.6	38.7	40.6	52.3	40.9	43.4	59.1	56.5	71.2	69.8	69.9	73.8	72.4	56.6	51.8	56.3	66.8	63.0	59.2	56.4	56.3	64.9	66.4
	L90	35.9	29.7	29.2	38.0	40.2	51.3	38.7	40.5	56.9	54.4	59.8	57.4	57.9	65.3	62.7	52.1	47.7	51.7	62.5	58.5	55.1	49.9	51.1	62.0	60.7
	Leq	40.3	30.0	30.4	39.0	40.7	53.4	41.3	44.2	59.5	56.7	75.0	73.9	74.4	78.8	79.1	59.4	52.7	57.3	67.7	64.0	62.8	59.7	59.8	65.9	73.2
R1	L1	42.0	44.9	55.5	47.3	58.3	59.4	58.9	64.6	63.9	65.6	100.7	99.0	99.2	88.8	88.2	76.2	73.0	76.0	72.7	68.8	89.8	87.0	87.4	74.4	82.0
	L10	39.9	33.0	41.0	41.0	42.5	56.4	49.1	52.0	61.5	59.2	91.2	90.1	91.5	83.7	79.3	65.8	64.7	67.5	70.3	66.6	78.7	77.3	77.3	69.0	72.6
	L50	33.1	30.0	29.6	38.4	40.3	49.5	44.6	45.9	59.1	56.3	80.1	79.8	81.4	75.0	65.7	57.5	56.7	59.7	67.0	62.5	66.6	65.7	65.8	65.2	62.7
	L90	32.0	29.7	29.1	37.4	40.3	46.4	40.1	41.9	56.8	65.7	65.9	66.7	66.0	67.2	52.0	51.3	54.5	63.1	58.9	56.4	55.4	62.2	68.2		
	Leq	54.5	34.3	43.4	39.7	67.1	66.7	48.6	53.1	59.6	79.8	89.0	87.0	87.8	79.6	84.3	74.4	62.3	66.5	67.8	86.8	78.9	75.1	75.4	66.7	83.3
R1	L1	32.3	31.1	28.9	31.0	49.7	52.1	47.0	46.3	45.1	62.1	92.0	91.1	91.2	91.8	91.5	66.8	64.7	64.7	65.0	72.2	79.7	79.7	80.1	80.4	87.0
	L10	30.1	30.6	28.7	30.4	48.5	49.5	44.6	43.6	42.6	60.3	87.7	87.0	87.1	87.7	83.2	64.1	61.2	61.5	61.3	69.4	75.3	75.4	75.7	76.0	80.1
	L50	29.7	30.3	28.5	30.1	47.2	45.7	41.9	39.8	39.6	58.4	79.2	78.8	78.8	79.6	74.5	60.0	56.2	56.8	55.0	60.7	67.7	67.7	68.1	68.5	71.6
	L90	29.5	30.0	28.3	29.8	45.9	41.5	39.4	36.0	37.4	56.6	65.6	64.6	64.9	65.4	66.7	55.2	51.6	51.7	57.0	61.6	61.4	57.9	58.2	49.4	66.6
	Leq	34.0	30.3	28.5	30.2	47.3	48.5	42.5	40.8	40.4	58.7	83.2	82.6	82.6	83.3	80.2	61.4	57.9	58.2	57.4	66.6	71.6	71.6	71.6	71.6	71.6
R2	L1	45.3	31.7	35.6	38.3	54.9	63.2	53.9	51.5	61.0	64.7	102.2	101.6	101.0	100.7	92.4	77.8	75.3	74.7	77.0	73.9	90.8	91.2	90.2	89.7	86.9
	L10	37.0	30.9	30.2	32.2	50.4	53.1	46.7	46.2	48.5	62.3	91.4	91.0	91.1	92.0	85.2	67.7	64.9	65.2	66.4	71.2	77.1	76.9	77.3	78.0	79.6
	L50	30.3	30.5	28.6	30.4	48.8	48.8	43.7	42.1	42.4	60.2	82.4	82.1	82.4	83.3	76.5	62.6	58.9	59.5	59.1	67.5	68.5	68.0	68.8	69.5	72.8
	L90	29.7	30.1	28.3	30.1	47.5	44.2	41.2	38.0	39.3	58.3	69.0	68.6	68.9	70.2	68.7	57.7	53.8	54.0	52.3	63.4	59.7	58.4	59.6	60.0	66.8
	Leq	34.9	30.5	29.4	31.6	58.0	54.3	45.3	44.9	51.5	62.5	89.5	89.2	88.8	89.2	81.8	68.0	63.3	63.5	66.0	68.4	78.6	78.7	77.8	77.5	76.7
R2	L1	38.8	31.3	31.0	36.8	52.1	55.6	49.4	51.8	53.7	63.0	93.0	93.0	93.1	93.9	90.1	69.1	66.7	68.1	68.0	72.7	80.5	80.6	81.1	81.5	85.0
	L10	32.5	30.7	28.9	31.2	49.2	51.1	45.4	44.8	46.0	61.0	89.0	88.9	89.1	89.7	83.7	65.5	62.9	63.5	63.7	69.9	75.7	75.7	76.2	76.5	78.5
	L50	23.3	36.1	35.0	28.5	47.8	47.0	42.6	40.7	41.5	59.0	81.2	80.9	81.3	81.9	74.7	61.3	57.6	58.1	57.5	66.4	67.3	67.7	68.1	68.5	71.6
	L90	29.6	30.0	28.3	29.9	46.6	42.9	40.1	36.8	38.6	57.2	67.7	67.7	68.1	68.4	67.3	56.6	52.8	52.9	51.3	62.1	59.1	58.3	58.7	59.0	65.5
	Leq	31.4	30.5	28.8	31.1	48.5	48.6	43.5	43.6	44.5	59.4	84.7	84.5	84.7	85.4	80.0	62.7	59.6	60.6	60.2	67.2	71.6	71.6	72.0	72.5	75.1
R2	L1	37.5	31.2	30.7	35.4	50.6	53.8	48.6	47.7	49.7	63.3	93.1	92.8	93.1	93.9	93.2	67.9	66.4	66.7	67.3	73.4	79.7	79.7	80.1	80.4	87.0
	L10	32.7	30.7	29.0	31.0	49.3	50.9	46.0	45.0	44.9	61.7	88.9	88.7	88.9	89.6	86.2	65.1	62.9	63.1	63.1	70.8	75.3	75.4	75.7	76.0	80.1
	L50	30.1	30.3	28.6	30.0	47.8	47.1	43.2	41.3	41.5	59.8	80.3	80.1	80.2	81.0	76.7	61.3	57.8	58.3	61.9	67.2	67.9	67.9	68.3	68.6	72.7
	L90																									

CONCLUDING REMARKS

In an effort to determine acoustical conditions that could be linked to apparent intense reaction by some Shirley environs homeowners, simultaneous indoor and outdoor acoustic and local wind speed measurements were conducted sequentially at three disparate locations over a three-day period starting the evening of December 4, 2012. A very large compendium of raw and processed data was obtained, a small fraction of which is presented in this summary.

The apparent and tentative result indicates that at the second residence, located approximately 1,280 ft from the nearest turbine, blade-passage induced infrasound was correlated between outdoor and indoor locations and peak amplitudes of periodic waves composed of blade harmonics 0.7 to 5.6 Hz on the order 76 dB were detected both indoors and outdoors. Well correlated broadband low frequency noise at this nearest residence was also detected, with one-third octave band sound pressure levels approximately 50 dB in the frequency range 16-25 Hz. Both of these sounds are below normal hearing threshold; residents report being intensely affected without audibility.

At the other two residences, located approximately 3,300 and 7,100 ft from the nearest turbine, respectively, high levels of infrasound were detected indoors but the correlation with outdoor acoustic signals was not clear except at the 3,300 ft residence, where the broadband noise in the 20 Hz range was moderately correlated and produce one-third octave band level approximately 40 dB, which is well below normal hearing threshold. At the 7,100 ft residence, outdoor-to-indoor correlation was low except during motor vehicle passages or in particular a helicopter overflight. Again, residents report being intensely affected despite inaudibility and to be aware of turbine operation when the turbines are not visible.

The author is not qualified to make judgments regarding human response to normally subliminal sources of acoustic excitation. A detection test has been proposed by the consortium of investigators and put forth by Dr. Schomer. The author concurs that this is an important step in resolving a difficult issue.

An additional missing element in the program is ability to correlate acoustic test results with turbine operating conditions. Near-turbine acoustic monitors placed by HAI showed significant variability in near-field sound levels for turbines WTG6 and WTG8 over the course of the program, with an indication that turbine noise emissions may have decreased shortly before the team started and increased shortly after the team stopped measuring on some days. Review of turbine SCADA records will show turbine-height wind speeds and directions and turbine power output as well as times when turbine were parked for flicker suppression or other purposes. This will help determine the program for additional measurements and/or if scaling of measured levels would be appropriate.

ⁱ B. Walker, Time Domain Analysis of Low Frequency Wind Turbine Noise, Low Frequency Noise 2012, Stratford Upon Avon, UK

APPENDIX B
by
HESSLER ASSOCIATES, INC.

Appendix B to Report Number 122412-1

1. Introduction

Hessler Associates concentrated on acquiring data to define the low frequency issue at the Shirley site using four Norsonics Model N-140 ANSI Type 1 precision instruments (NOR140). These systems with the standard microphone and preamp are rated at an accuracy of +/- 1 dB from 5 Hz to 20,000 Hz. Two of the systems were used as continuous data loggers and the other two for relevant attended measurements. The systems were also calibrated against the extended frequency range system brought by Channel Islands Acoustics (ChIA).

2. Calibration

Two NOR140 units were set-up in the living room of residence R2 adjacent to the high performance ChIA microphone, which is rated accurate from 0.1 Hz to 20,000 Hz. The results of a 10-minute run between the three systems, along with a photograph of the set-up, are shown below. It is clear from the test that the NOR140 off-the-shelf unit can be used with confidence down to about 2 Hz; significantly better than its 5 Hz rating.

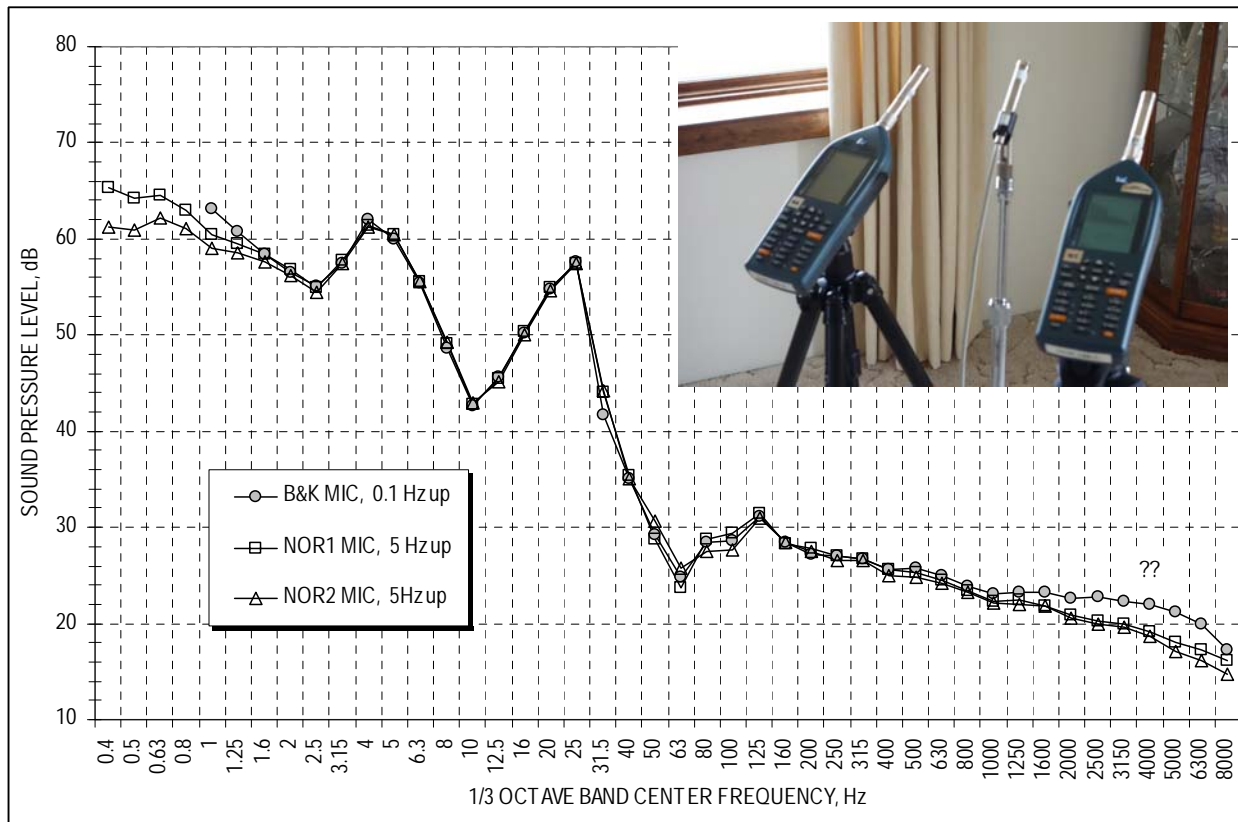

Figure 2.1 Instrument Calibration Check Relative to High Performance ChIA System

3. Data Logger

Because Duke Power would not participate in the test, it became necessary to install an automated sound level recorder near Turbine 6 to get a sense of what load that turbine, and presumably the remainder of the project, was operating at - and, indeed, whether the turbines were operating at all. The test position, designated as Monitor 1, is shown in Figure 2.1 in the cover report. A plot for each 10-minute interval in terms of the L50, L90 and Leq statistical metrics is given below.

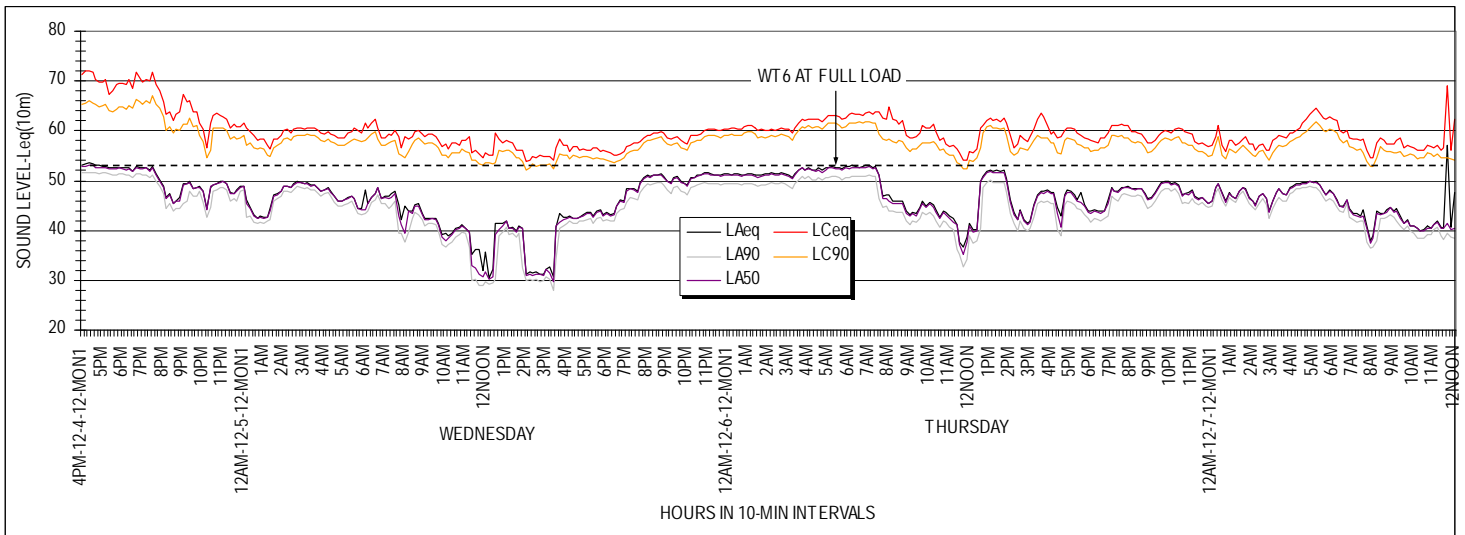

Figure 3.1 *Monitor 1 Results*

Calculations indicate that the turbine is at full power when the sound pressure at the monitor is approximately 53 dBA. In general, the plot shows when the unit was near or at full power and when it was off (e.g. around midday on Wednesday when the sound level dropped to about 31 dBA).

The second long-term logger, Monitor 2, which was located in front of the residence at R2, was not as useful because it was strongly influenced by extraneous, contaminating noise from traffic on Glenmore Road. Nevertheless, the results are given below in Figure 3.2.

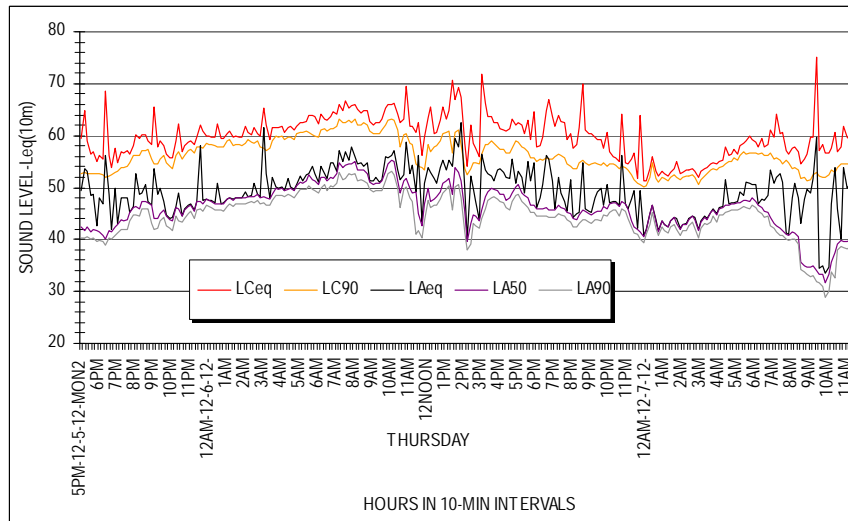

Figure 3.2 *Monitor 2 Results*

4. OUTDOOR/INDOOR Measurements

Measurements of the frequency spectra inside and outside of each of three residences on Wednesday night and early Thursday morning while the turbines were operating near full power are plotted below.

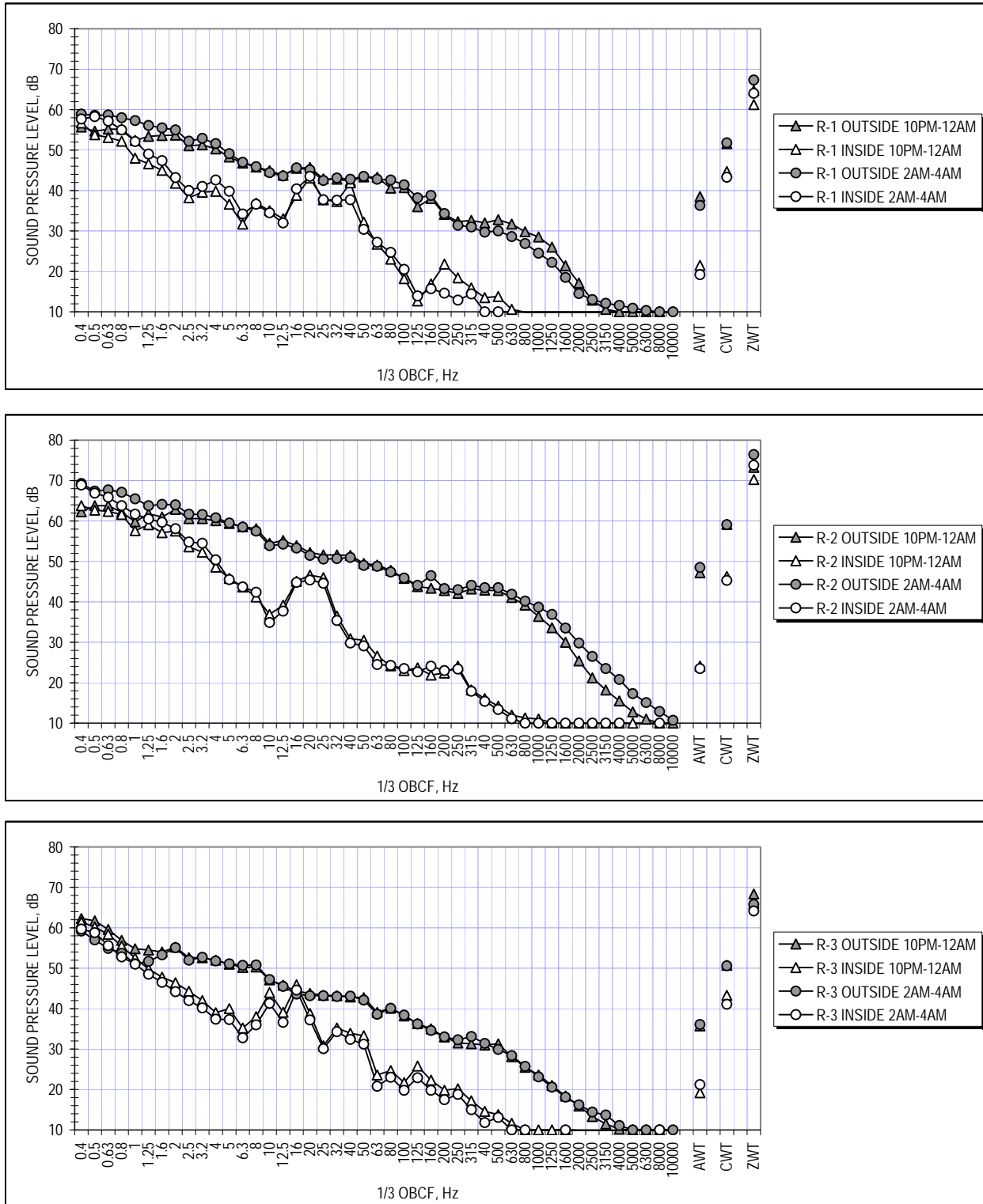

Figure 4.1 Inside/Outside Sound Levels during Project Operation

These figures are 10-minute L50 samples made simultaneously outside and inside of the three residences between 10 p.m. and midnight and between 2 and 4 a.m. The measured levels below 1 or 2 Hz may be pseudo noise, or false signal noise from the wind blowing over the microphone, even though the microphone was placed on a reflective ground board under a 7" hemispherical windscreen to minimize this effect. The plotted outdoor levels are the raw measurement results obtained on the reflective ground plane and should be reduced by 3 dB to reflect a standard measurement 1.5 meters above grade. Maximum levels occur at R-2 as one would expect, since it is closest to the turbines and the location where wind turbine noise was most readily audible.

What is significant about these plots is that there is a low frequency region from about 10 to 40 Hz where the noise reduction of each house structure appears to be weakest. This behavior is attributed to the frequency response of each structure, which is known to be in this frequency range. The small differences in the magnitude and frequency of the interior sound levels in this region of the spectrum are largely associated with differences in construction, design, openings, etc. The question is: what is the driving or excitation force in this range? It could be acoustic noise immissions from the wind turbines, normal environmental sources (mostly traffic), the natural response of each structure to varying wind pressure or some combination of these causes. The only sure way to discover the driving force is to turn off the wind turbines for a short period to see if the spectrum changes without the turbines in operation. This type of on/off testing was requested in the first test protocol and these rather inconclusive results make it clear that such an approach is essential to the task of identifying and quantifying the sound emissions specifically from the turbines inside of these homes.

5. ON/OFF Measurements

In the course of taking some supplemental outdoor measurements of the turbine closest to R-2 at least one on/off sample, although outdoors, was obtained through happenstance. After several measurements at a position 269 m WNW of WTG8, with the turbine in operation at some intermediate load in light winds from the north, the unit was unexpectedly shutdown by O&M personnel. Additional measurements were immediately obtained with all variables constant except for turbine operation. Prior to shutdown the rotor was turning at 11 rpm, which equates to a blade passing frequency of 0.55 Hz. The resulting on/off spectra are plotted below in Figure 5.1.

One could conclude that the wind turbine was not producing any low frequency noise since the spectra are essentially equal from 0 to 12.5 Hz; however, despite measuring on a hard surface using a hemispherical windscreen, the low end of both spectra appear to be pseudo, or false-signal noise based on some recent empirical tests of windscreen performance carried out in the Mohave Desert (in support of a new ANSI standard that is being developed for measuring in windy conditions). The objective of this testing was to evaluate measured low frequency sound levels in a moderately windy environment without any actual source of low frequency noise. The on/off measurements of WTG8 show that the levels below about 20 Hz coincide with the sound levels measured in the desert in the presence of a light 1 to 2 m/s wind. Consequently, all that can be concluded is that the low frequency emissions from the turbine were substantially lower in magnitude than the distortion effect produced from a nearly negligible amount of airflow through a 7" windscreen and across the ground-mounted microphone.

The overall reduction in audible sound of 8 dBA is attributable to eliminating the "whoosh" sound, which is clearly seen to occur in the higher frequencies; generally from about 200 to 2000 Hz.

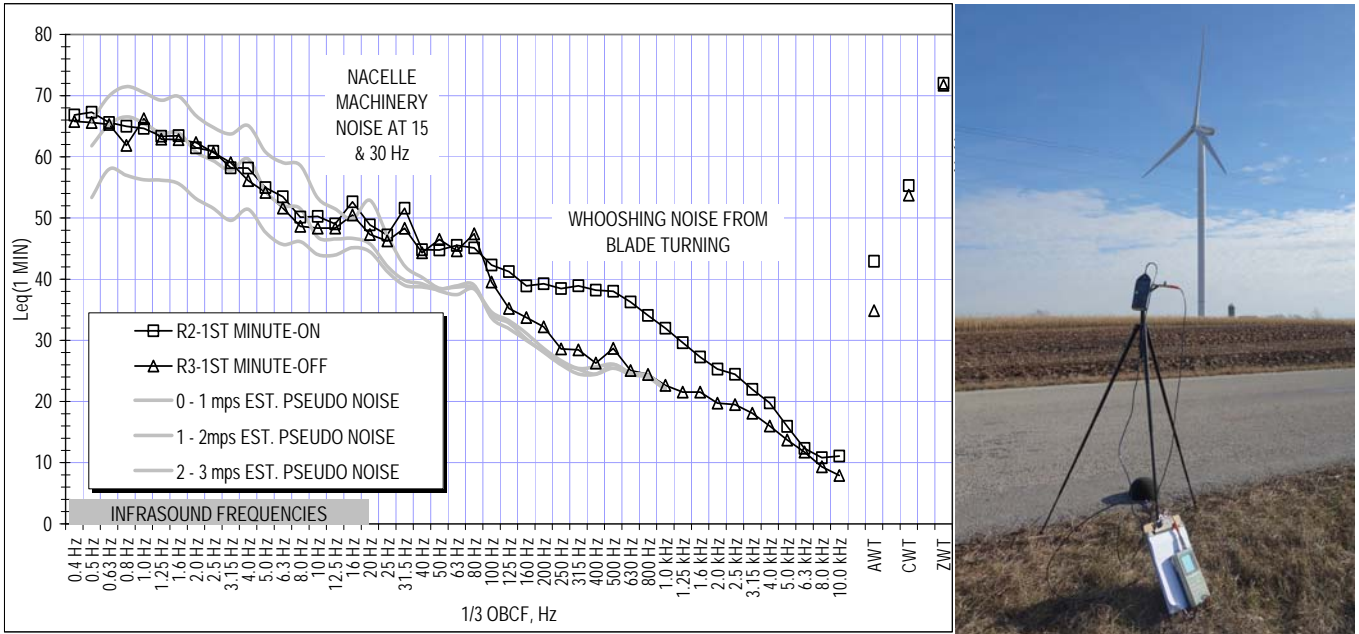

Figure 5.1 On/Off Sound Levels Outdoors during Project Operation

6. Proposed Method for Measuring Outdoor LFN in Wind

The experience above with on/off measurements outdoors can be combined with a finding made by Walker and Schomer that LFN inside a dwelling was quite uniform throughout all the rooms in the house, and not, as one might intuitively imagine, in the rooms facing the nearest turbine. This prompted them to measure the sound level inside of a vehicle, an SUV, and compare it to the levels measured inside the residence. It was found that the low frequency levels inside the car were similar to those inside the adjacent dwelling. Since an SUV is a closed, wind-free volume, it follows that the problem of obscuring pseudo could be eliminated with such measurements and accurate narrow band measurement of extreme low frequency sound could be measured inside of a car. The spectrum for a wind turbine shows up as a distinct pattern of peaks beginning at the blade passing frequency (about .5 to 1 Hz for modern wind turbines) with several following harmonic peaks that positively identify wind turbine low-frequency infrasound immissions. The beauty of the system sketched below in Figure 6.1 is that it is mobile and can be used at any public access near or far from a wind farm.

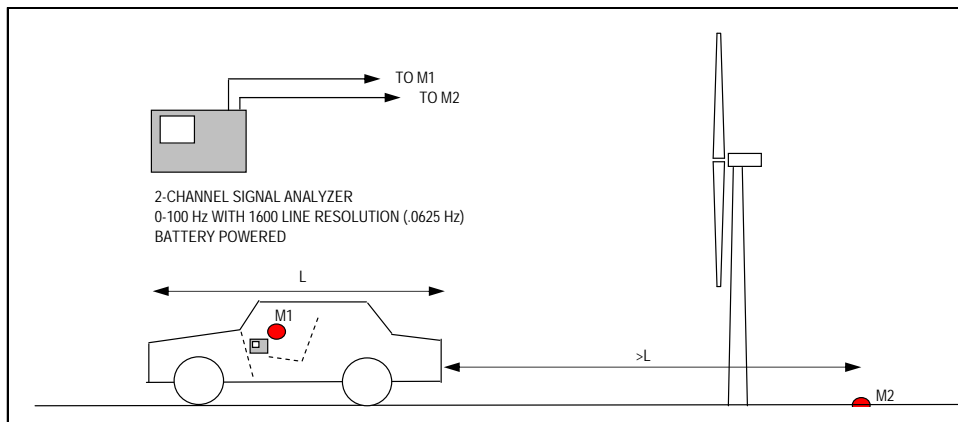

Figure 6.1
Schematic of Alternative, Mobile Measurement Technique for Low Frequency Sound Emissions from Wind Turbines

7. Conclusions

Walker showed unequivocally that low level infrasonic sound emissions from the wind turbines were detectable during near full load operation with specialized instrumentation inside of residence R2 as a series of peaks associated with harmonics of the blade passing frequency. The long-term response of the inhabitants at R2 has been severely adverse for the wife and child while the husband has experienced no ill effects, which illustrates the complexity of the issue. The family moved out of the area to solve the problem.

The industry response to claims of excessive low frequency noise from wind turbines has always been that the levels are so far below the threshold of hearing that they are insignificant. The figure below plots the exterior sound level measured around 2 a.m. on a night at R2 during full load operation compared to the threshold of hearing. In the region of spectrum where the blade passing frequency and its harmonics occur, from about 0.5 to 4 Hz, the levels are so extremely low, even neglecting the very real possibility that these levels are elevated due to self-generated pseudo noise, that one may deduce that these tones will never be audible. What apparently is needed is a new Threshold of Perception.

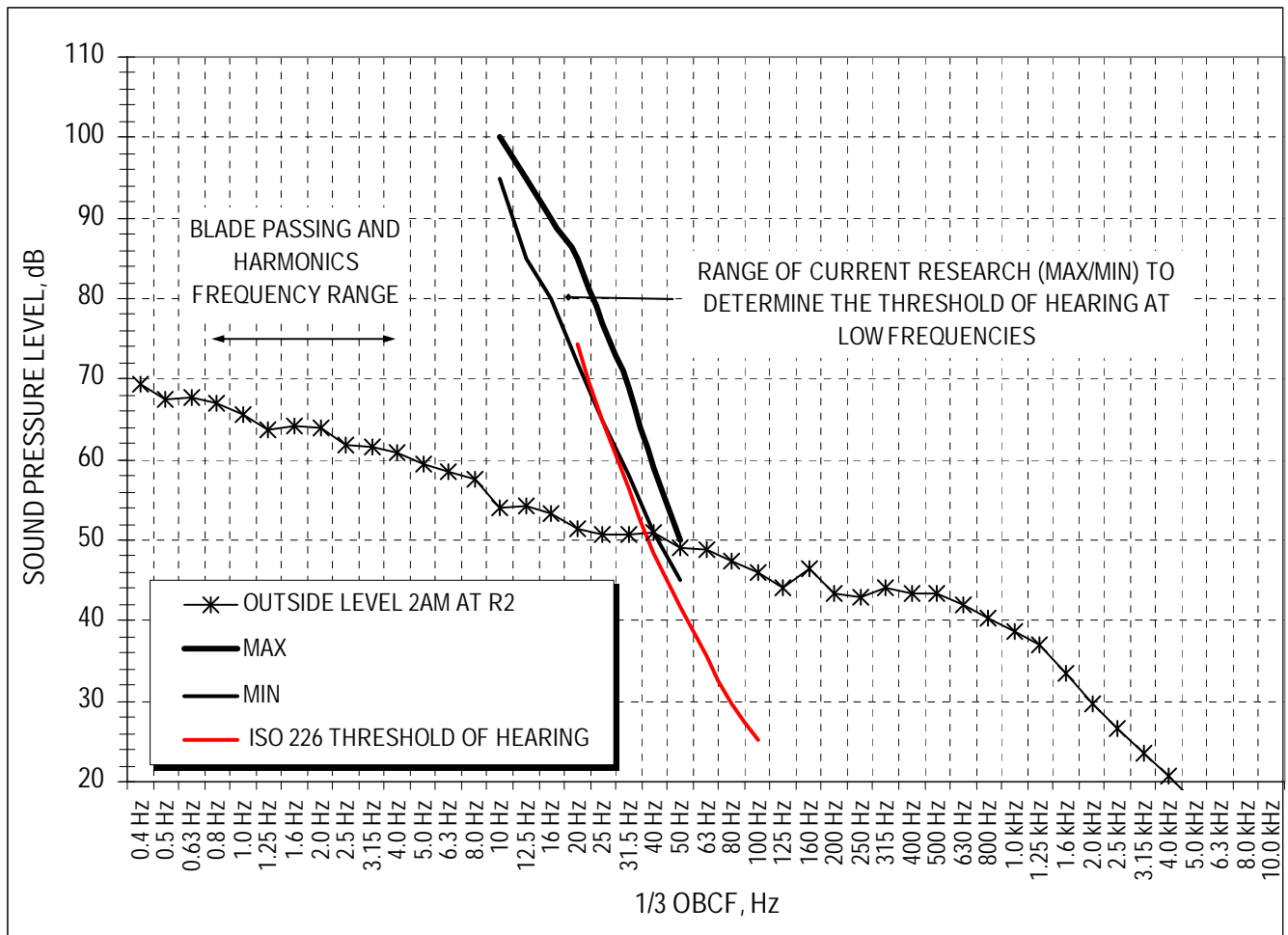

Figure 7.1 Measured Project Sound Level Compared to Threshold of Hearing

The study also showed that a wind turbine is indeed a unique source with ultra low frequency energy. The next figure plots the same R2 data above compared to a more commonly recognized low frequency noise source, an open cycle industrial gas turbine complex sited too close to homes. These two sources of electrical energy production, assuming the low end of the wind turbine measurement is actually due to the turbine rather than pseudo noise, have about the same A-weighted and Z-weighted overall sound levels.

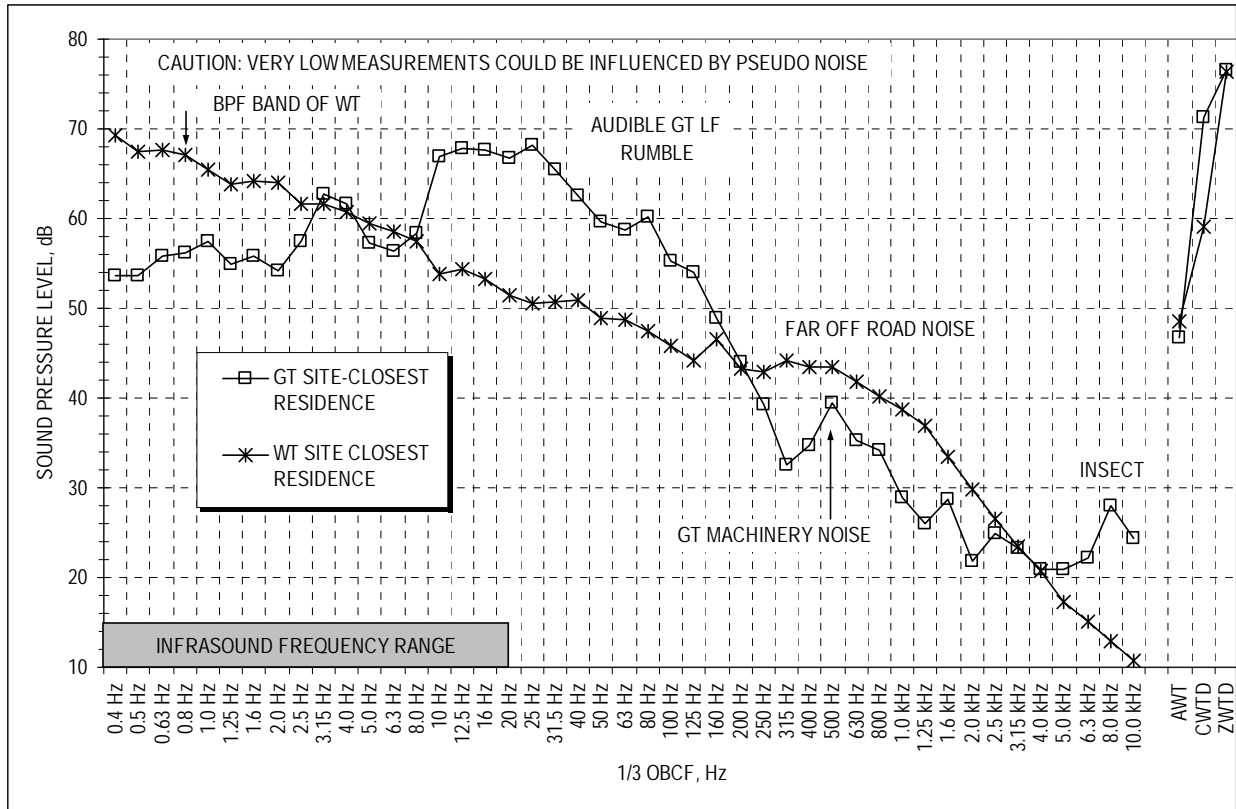

Figure 7.2 As-Measured Wind Turbine Spectrum Compared to Gas Turbine Sound Level

The C-weighted sound level is often used as a measure of low frequency noise; most commonly in gas turbine applications. If the C minus A level difference of a source is 15 to 20 dB, further investigation of the source is recommended by some test standards, since that apparent imbalance may be an indicator of excessive low frequency content in the sound. In this instance, the C-A level difference for the wind turbine is only 11 dB compared to 25 dB for the gas turbine, so this metric does not appear to work for wind turbines.

Schomer and Rand contend that the illness that is being reported may be a form of motion sickness associated with the body experiencing motion in approximately the same frequency range as wind turbine blade passing infrasound. However, this conjecture is based on a Navy study in which subjects were physically vibrated in flight simulators at amplitudes that may or may not be comparable to the situation at hand, whereas any such force from a distant wind turbine would need to be conducted through the air. One must make the leap that motion of the body in still air is the same as being still in air containing some level of infrasound. While potentially plausible this hypothesis needs to be verified.

Hessler and Walker have measured overall A-weighted sound levels and levels of infrasound at numerous wind farms that substantially exceed those measured here and to the best of their knowledge there are no reported adverse effects for noise or adverse health issues. It would be informative, in any further study, to survey the reactions of project participants and possibly other neighbors close to turbines, particularly with regard to health effects.

In general, enough was learned by these investigators, all with quite different past experiences, that it can be mutually agreed that infrasound from wind turbines is an important issue that needs to be resolved in a more conclusive manner by appropriate study, as recommended in the cover report.

End of Text

APPENDIX C
by
RAND ACOUSTICS

December 21, 2012

Investigations of infrasonic and low-frequency noise
Shirley Wind Facility, Wisconsin, December 4-7, 2012

1.0 Introduction

This report presents information on an investigation of infrasonic and low frequency noise performed at the Shirley Wind facility in Wisconsin December 4-7, 2012. The investigation was conducted by acousticians Dr. Bruce Walker, George Hessler, Dr. Paul Schomer, and Robert Rand under a Memorandum of Agreement developed for the investigation by Clean Wisconsin and Forest Voice. Mr. Hessler was accompanied by his son David Hessler. During the investigation, unexpectedly another consultant, Mr. Michael Hankard, visited the team and entered the homes under investigation during testing.

The investigation was conducted using instrumentation provided and employed by the acousticians. Three homes were investigated that had been abandoned by the owners due to negative health effects experienced since the Shirley Wind facility had started up. The health effects were reported to make life unbearable at the homes and had affected work and school performance. It was understood that once relocated far away from the facility, the owners and families recovered their health; yet revisiting the homes and roads near the facility provoked a resurfacing of the adverse health effects. The owners had documented their experiences in affidavits prior to the investigation.

This team functioned very well together with a common goal, and found collectively a new understanding of significant very low frequency wind turbine acoustic components that correlated with operating conditions associated with an intolerable condition for neighbors.

2.0 Methodology

It was generally understood that Dr. Walker would acquire simultaneous multi-channel, wide-bandwidth, high-precision recordings for later analysis. If successful and clear of contamination, those recordings would form the primary database for the investigation. George Hessler would acquire precision sound level meter measurements to correlate with wind turbine operations and for his project requirements. Paul Schomer and Rob Rand would serve as observers and, would also analyze and acquire measurements according to their investigative needs during the test. Measurements by acousticians would be catalogued and made available for later research and analysis. These general understandings were not detailed in the MOU due primarily to time constraints for the unusual, unprecedented collaboration brought together for this investigation.

Having investigated other wind turbine facilities and directly experienced the negative health

effects reported by others living near wind turbines [1,2], Mr. Rand focused on acquiring neighbor reports on health impacts during and prior to testing and correlated those to data being acquired. The working assumption borne out by experience is that the human being is the best reporting instrument.

Correlation: When investigating community noise complaints, value can be derived from measurements and analysis primarily when they are highly correlated to neighbor reports. In simple terms: if a recording or analysis is made when the turbines are turning, and the neighbors are present and report feeling intolerable, tolerable, or not a problem, and report such details as headache, nausea, vomiting, dizziness, vertigo, or cloudy thinking, or the absence of health effects, the correlation to the neighbor reports provides very useful information for assessing the utility of those data. Without the neighbor reports, it is difficult to determine the significance of acoustic data. From details given in neighbor reports, the investigators can look for unusual or distinctive acoustic characteristics or differences to clarify what acoustical conditions correspond to the degree of health effects being reported.

Self-reports taken as valid: The team agreed prior to testing that neighbor reports would be useful. They also agreed that neighbor reports are sincere and truthful, not "claims" as often alleged by the wind industry. Neighbors considered and agreed to requests to be available during testing. Mr. Rand also agreed to note his condition during the testing, since unlike the other acousticians he is prone to seasickness and has also proved vulnerable to negative health effects when near large wind turbines.

Due to schedule constraints, Mr. Rand was unable to attend a preliminary meeting with the owners of the three homes during the midday on Tuesday, December 4. However he met with the owners during the evening of December 4 shortly after arriving, and observed and acquired owner health reports and noted his own health over the next three days.

2.1 Equipment

Equipment used by Mr. Rand included:

- Gras 40AN microphone
- Larson Davis Type 902 Preamplifier
- Larson Davis Type 824 Sound Level Meter
- M-Audio MicroTrackII 24-bit line-level audio recorder
- Bruel & Kjaer Type 4230 Acoustic Calibrator
- SoundDevices USBPre audio interface
- Infiltec Model INFRA-20 seismometer (acoustic pressure, 0.1 to 20 Hz)
- SpectraPlus 5.0 acoustic analysis software
- Amaseis helicorder datalogger software

1 Robert W. Rand, Stephen E. Ambrose, Carmen M. E. Krogh, "Occupational Health and Industrial Wind Turbines: A Case Study", Bulletin of Science Technology Society October 2011 vol. 31 no. 5 359-362.

2 Ambrose, S. E., Rand, R. W., Krogh, C. M., "Falmouth, Massachusetts wind turbine infrasound and low frequency noise measurements", Proceedings of Inter-Noise 2012, New York, NY, August 19-22.

2.2 Protocol

Measurements would be obtained during higher-wind conditions as possible to derive a contrast from low- or no-wind conditions at the three homes under investigation. A "control" home in a quiet location far away from the Shirley Wind facility would be measured to provide background acoustic levels and signatures with no wind turbines nearby. Walker measurements would be observed and discussed and independent analysis performed by the observers as possible during the testing. The first primary goal was to obtain clean precision audio recordings for later analysis. The second primary goal was to obtain neighbor reports and discern acoustic contrast during the field investigations for immediate reporting of significant noise components to concerned parties. Mr. Rand would remain attentive to and report his health state during the testing.

At times during the testing Mr. Rand moved to other locations independently of the Walker system because of easier instrumentation mobility and to reduce noise contamination from activity by the other investigators.

3.0 Data collected

Mr. Rand took notes on health reports during the investigations, conveyed his state to the team during the testing, and compiled notes for later analysis, provided in Table 1. Neighbors were interviewed and they assembled reports for the team's use, listed in Table 2.

Mr. Rand referred primarily to Dr. Walker's acoustic recordings and analysis during testing and analysis. He acquired recordings and infrasonic acoustic pressure data separately for backup and reference.

Weather data were obtained from Wunderground as shown in Table 3.

Note: Although requested prior to the survey and again while at the site, Mr. Hessler made a decision not to acquire acoustic data with the Walker system at a control home far away from the Shirley Wind facility, citing "too many variables."

4.0 Analysis

Analysis focused on health state and, the levels and time-varying waveforms during higher-wind conditions when neighbors reported conditions as intolerable or difficult, versus quieter conditions which neighbors reported as tolerable.

5.0 Results

Results are preliminary. Nausea was experienced and **nauseogenicity** is indicated.

5.1 Neighbors report either tolerable or intolerable conditions, with little rating scale in

between. They said if the turbines are operating, it's intolerable. Mr. Rand observed neighbors unable to stay at the homes at times even under moderate wind conditions during the testing.

5.2 Neighbors do not always hear the turbines. The neighbors indicated there is no real difference in wind compass direction on the negative health effects. The house could be upwind, downwind or crosswind to the turbine; no difference.

5.3 Neighbors retreated to the basement and gained partial relief from symptoms. Tested sound levels are the same everywhere in the home except less in the basement. Lower sound levels in the basement matches the neighbor reports to Mr. Rand to the effect that, when the turbines are operating, it's about the same level of difficulty everywhere in the house, except the basement, where they would retreat to gain partial relief, until they either left or abandoned the home to get substantial relief. The neighbors reported that they felt a need to get outside when conditions were intolerable. Their reports are supported by and correlate to the ubiquitous presence of the acoustic energy inside in all locations, except in the basement where it is slightly less. The neighbors take to the basement or if that is not sufficient to gain relief, they leave the home.

5.5 Acoustic energy outside was strongly coupled into the home at infrasonic frequencies when turbines operating in design range. Neighbors reported feeling worst when turbines are turning compared to light-wind conditions with some or all turbines off when they report using words such as "tolerable". Coherence between outdoor and indoors time-series was high at infrasonic frequencies below 8 Hz when wind turbines operating compared to when wind turbines off or turning slowly in light winds.

5.6 Neighbors reported being highly annoyed by the interior sound. Elevated acoustic energy was observed inside all three homes in the range of 10 to 40 Hz. Room, house, wall and floor acoustic modes (resonant frequencies) are found in the 10 to 40 Hz range. The Nordex N100 has in-flow turbulence noise at a peak frequency of 9 to 14 Hz depending on rotational speed, which might be involved in exciting resonant frequencies in walls and floors. More analysis and/or survey work appears needed to determine the extent of the problem. Mr. Rand was able to discern panel excitation in R3 where the owner reported feeling pressure on his ears as he moved toward the southerly wall of the sitting area in the open-area. Two wind turbines operating at a distance were faintly audible in R3 and detectable with ear to wall. Dr. Walker and Mr. Rand discussed the sensation, examined the walls, and made measurements of the home room dimensions for a future check of room modes against acoustic recordings.

5.7 Neighbors reported that at a distance of 3-1/2 miles, they could find relief when turbines were operating. Outdoor average sound levels at the nearest home R2, a distance of 1100 feet, were measured at approximately 48 dBA. Assuming 6 dB per doubling of distance for the A-weighted sound level, a probable A-weighted sound level at 3-1/2 miles is $48 - 20\log(1100/18480)$ or, 48-23 or, **25 dBA**. Measured infrasonic unweighted average levels outdoors were approximately 73 dB at 0.3 Hz at 1100 feet. Assuming 3 dB per doubling of

Investigations of infrasonic and low-frequency noise
Shirley Wind Facility, Wisconsin, December 4-7, 2012

distance (cylindrical spreading) [2][3] for infrasonic propagation, a probable average infrasonic level at 3-1/2 miles is $73-10\log(1100/18480)$ or, 73-12 or, **61 dB**. More work is needed to establish what infrasonic levels are consistent with relief for the neighbors.

The sample seismometer graph below shows the time varying waveform inside R2, the closest home at 121206 3:33 am with several turbines turning. Signal is filtered to pass the blade pass frequency and first four harmonics. Peak levels were 0.2 to 0.3 Pa (living room; scale shown approximately in milliPa), about 80 to 83 dB peak.

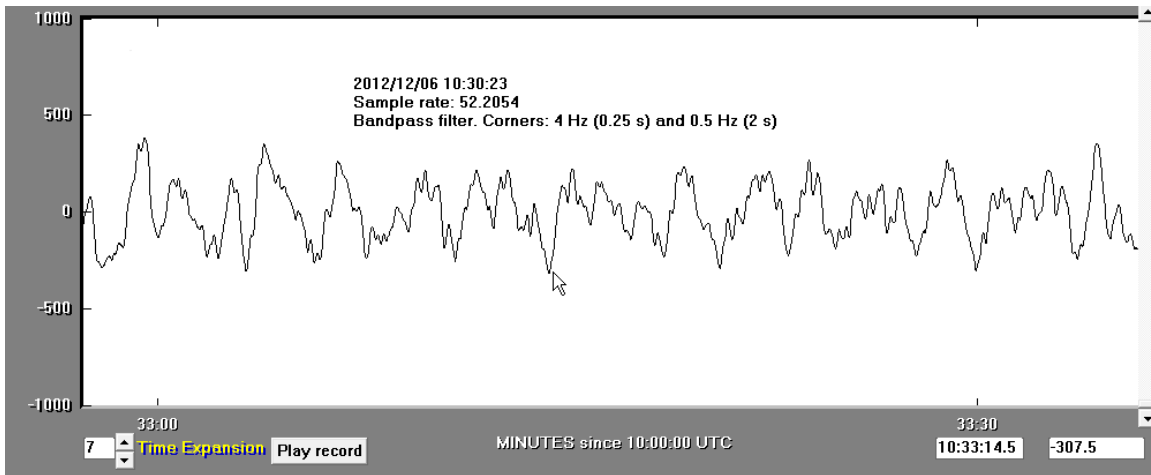

At R3 on 121207 110pm winds were light and the neighbors described the conditions as "tolerable" with no real problems. The sample seismometer graph below shows the time varying waveform for that period inside R3, the farthest home away in the testing. Peak levels were roughly 0.05 Pa (living room; scale shown approximately in milliPa), or about 50 dB peak. These results are preliminary and roughly similar to Dr. Walker's infrasonic data.

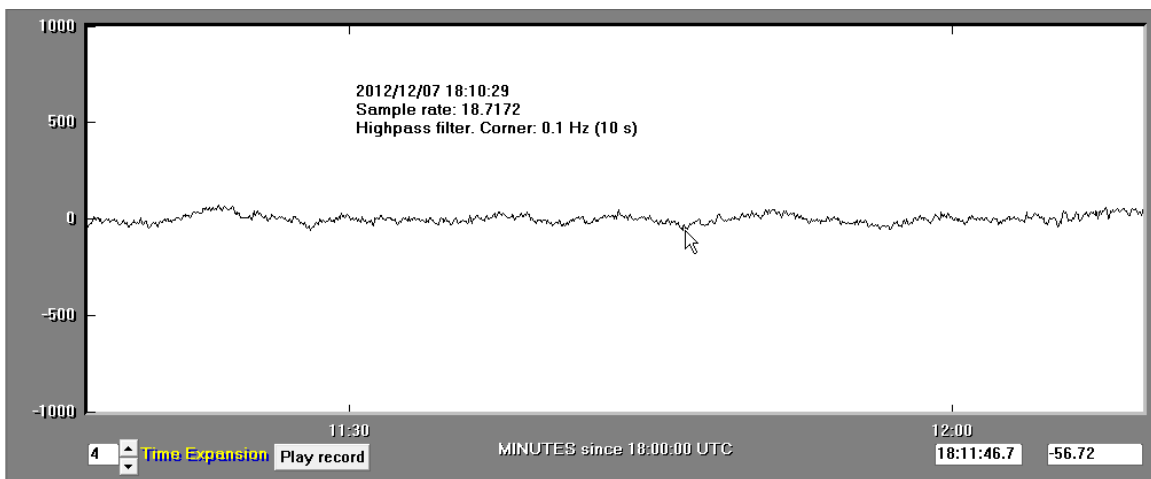

3 H. Møller and C. S. Pedersen: Low-frequency wind-turbine noise from large wind turbines. J. Acoust. Soc. Am. 129 (6), June 2011.

5.7 Negative health effects were experienced. During testing Mr. Rand experienced again [4] some of the adverse health effects reported by the neighbors. In effect, Mr. Rand "peer-reviewed" the neighbors by staying in two of the homes for extended periods of time overnight to experience what they are reporting. Mr. Rand slept in R1 the night of December 4th to assess the effects on sleep, and worked at R2 much of the second night (to 5:30 am) to assess audibility and effects while awake. Wind turbine sound levels were faintly detectable with interior sound levels in the range of 18-20 dBA. Note: Although he had arrived the previous night feeling good, on awakening on December 5 Mr. Rand felt nauseous (very unusual). To summarize, Mr. Rand encountered unusual negative health effects during the testing period when near the operating wind turbines, including, at various times:

- Nausea
- Headache
- Dizziness

Symptoms persisted after the testing for about a week, relieved by rest away from the site. The other investigators do not get seasick and did not report the same negative health effects.

Implications

A nauseogenic factor is present. Naval, aviation and other research has established human sensitivity to motion producing nausea. While mechanism for motion sickness is not well understood, "theories all describe the cause of motion sickness via the same proposition: that the vestibular apparatus within the inner ear provides the brain with information about self motion that does not match the sensations of motion generated by visual or kinesthetic (proprioceptive) systems, or what is expected from previous experience". The range of motion nauseogenicity has been measured at 0.1 to 0.7 Hz and with a maximum nauseogenic potential at 0.2 Hz [5][6] (see Figure 1). The Nordex N100 has a rotational rate of 0.16 to 0.25 Hz and a nominal blade passage rate of 0.5 to 0.7 Hz (three times the rotational rate). A hypothesis is suggested based on the limited, preliminary research correlating acceleration and nauseogenicity: ***Nauseogenicity is present at Shirley due to acceleration on inner ear from modulated, impulsive acoustic pressure at rotation and/or blade passage rates.***

Note: Wind turbines produce periodic acoustic pressure modulations at the rotation rate (per blade) and blade passage rate (per turbine), due to changes in wind speed and turbulence as blades are rotated top to bottom, and as they pass the tower where a pressure blow zone changes local wind speed. Pressure modulations at BPF with strong rates of change were documented by Dr. Walker (see Dr. Walkers report and the main report, conclusions).

4 Nausea/dizziness/headache (very unusual) experienced at three other wind turbine sites including Falmouth, MA, April 2011 (Vestas V82); Hardscrabble, NY, August, 2012 (Gamesa G90-2MW); Vader Piet, Aruba, October, 2012 (Vestas V90-3MW).

5 Samson C. Stevens and Michael G. Parsons, Effects of Motion at Sea on Crew Performance: A Survey. Marine Technology, Vol. 39, No. 1, January 2002, pp. 29–47.

6 Golding JF, Mueller AG, Gresty MA., A motion sickness maximum around the 0.2 Hz frequency range of horizontal translational oscillation. Aviat Space Environ Med. 2001 Mar;72(3):188-92.

Note: Wind turbines encounter stronger winds at the top of rotation compared to the bottom. As each blade rotates through a full turn (one revolution) the blade is forced, bent, or flexed back by stronger wind load at the top of rotation and then returns to a lesser amount of bending at the bottom of rotation (the bending moment). Flexing occurs at the rotation rate. It's hypothesized that the blade displaces or disturbs a volume of air proportional to bending moment, translating motion into sound pressure at the flexing frequency, just as a loudspeaker moves air by displacement. Blade flexing may also impart a forcing function into the tower then transmitted into the ground, traveling to the house which responds, yielding two paths for acceleration on the inner ear.

Figure 2 shows rotational rates in Hz for various wind turbine models, for the total frequency span of 0.1 to 1 Hz associated with nauseogenicity. As wind turbine MW ratings have increased, the blades have become longer and less stiff with larger bending moments, and the rotational rate has decreased. The operating rpm for the Nordex N100 is 0.16 to 0.25 Hz with blade pass rates at 0.5 to 0.7 Hz.

Under the hypothesis of nausea produced by a periodic forcing acceleration on the inner ear either at rotation or blade pass rates, the Nordex N100 operates in or near the documented range of highest potential for nauseogenicity. Earlier turbine models studied for annoyance (primarily the stall- regulated models shown) have shorter, stiffer blades with smaller bending moments and do not have rotation rates near the peak potential nauseogenic frequencies. Consistent with the hypothesis, a limited review of a previous wind turbine noise study on community effects near smaller wind turbines [3] did not find nausea.

The only range of frequencies capable of creating an identical level throughout an enclosed structure are frequencies with wavelengths significantly larger than the size of the enclosed volume (the house). This points to the lower infrasonic frequency range below 10 Hz. This is consistent with the nauseogenic hypothesis for a driving force near 0.2 Hz and, the highest sound levels which were measured in the range of 0.2-0.4 Hz (see main report) with the wind turbines turning at 9 to 14 rpm (0.16 to 0.25 Hz) with blade pass rates of 0.5 to 0.7 Hz. While the highest sound levels indoors were down near 0.2 Hz, the most strongly coupled acoustic frequencies were the first several multiples of 0.7 Hz.

Shirley neighbors reported sleep interference in affidavits. Sleep deprivation magnifies the occurrence of motion sickness because it interferes with the vestibular system habituation process [4]. Further, many people suffer the misery of motion sickness without vomiting [4].

Conclusions

Nauseogenicity is a factor at Shirley. Acceleration of the inner ear is suggested due to extremely low-frequency pulsations at the rotation and blade pass rates that occur in or near the frequencies of highest potential for nauseogenicity and, are coupled strongly into the homes now abandoned. More research at Shirley is recommended to understand nauseogenicity from wind turbine operations, to properly design and site large industrial wind turbines (over 1 MW) near residential areas to prevent the severe health effects. More work is needed to establish what infrasonic levels are consistent with relief for the neighbors.

Medical research and measurement is urgently needed to be field coordinated along with infrasonic acoustic and vibration testing. The correlations to nauseogenicity at the 2.5MW power rating and size suggest worsening effects as larger, slower-rotating wind turbines are sited near people.

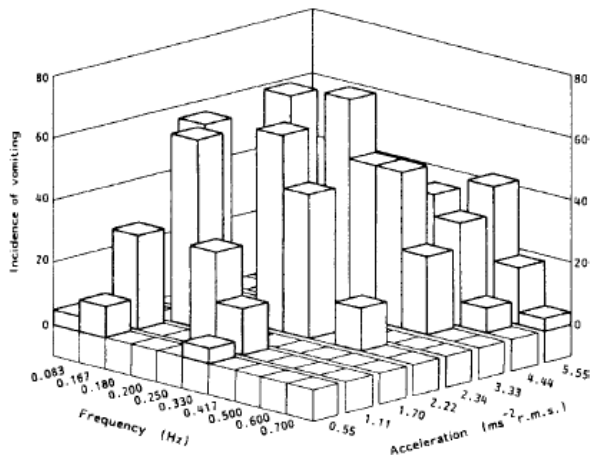

Fig. 5 Incidence of vomiting associated with exposure to various magnitudes and frequencies of vertical oscillation according to McCauley et al (1976)

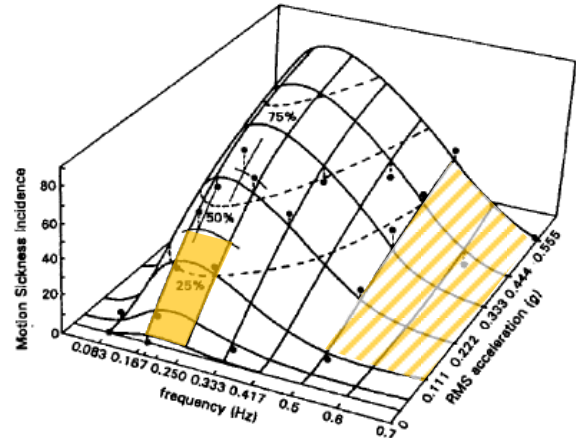

Fig. 6 The model of McCauley et al (1976), describing incidence of motion sickness with subjects inside a ship motion simulator moving sinusoidally in the vertical direction. Incidence of motion sickness was measured in terms of the percentage of subjects vomiting within 2 hours of exposure (Wertheim 1996a, Bos & Bles 2000)

Figure 1. From Stevens et al (2002) Figure 5 showing incidence of vomiting associated with vertical oscillation according to McCauley et al (1976) and modeled. Colored patches postulate association between rotational rate (solid), BPF(striped) and response at Shirley (nausea, did not vomit); acceleration level was not measured.

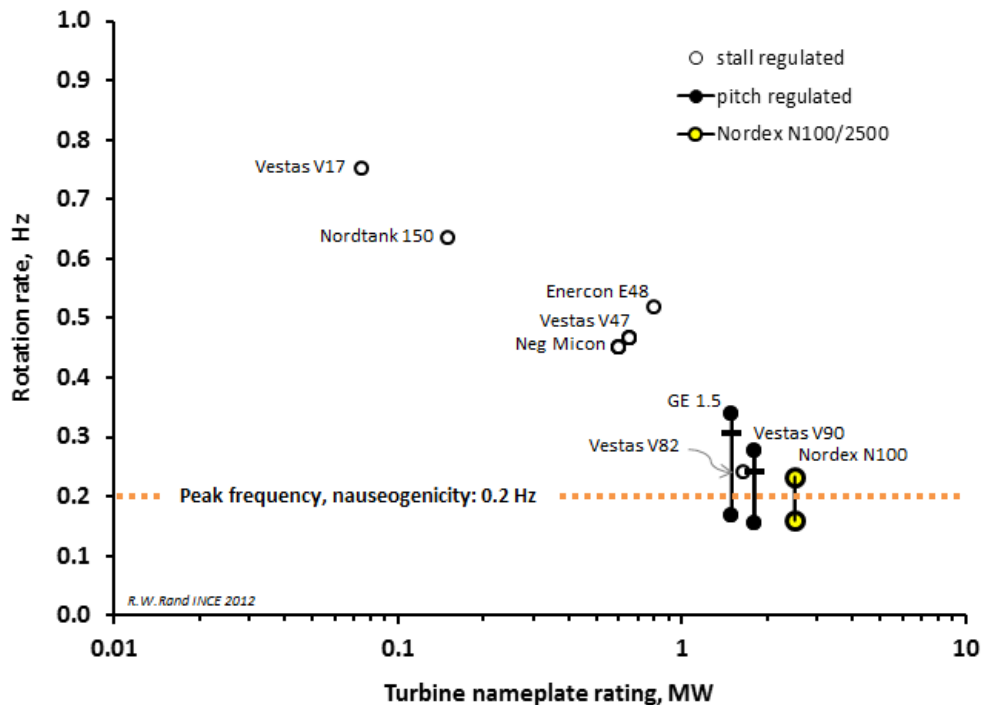
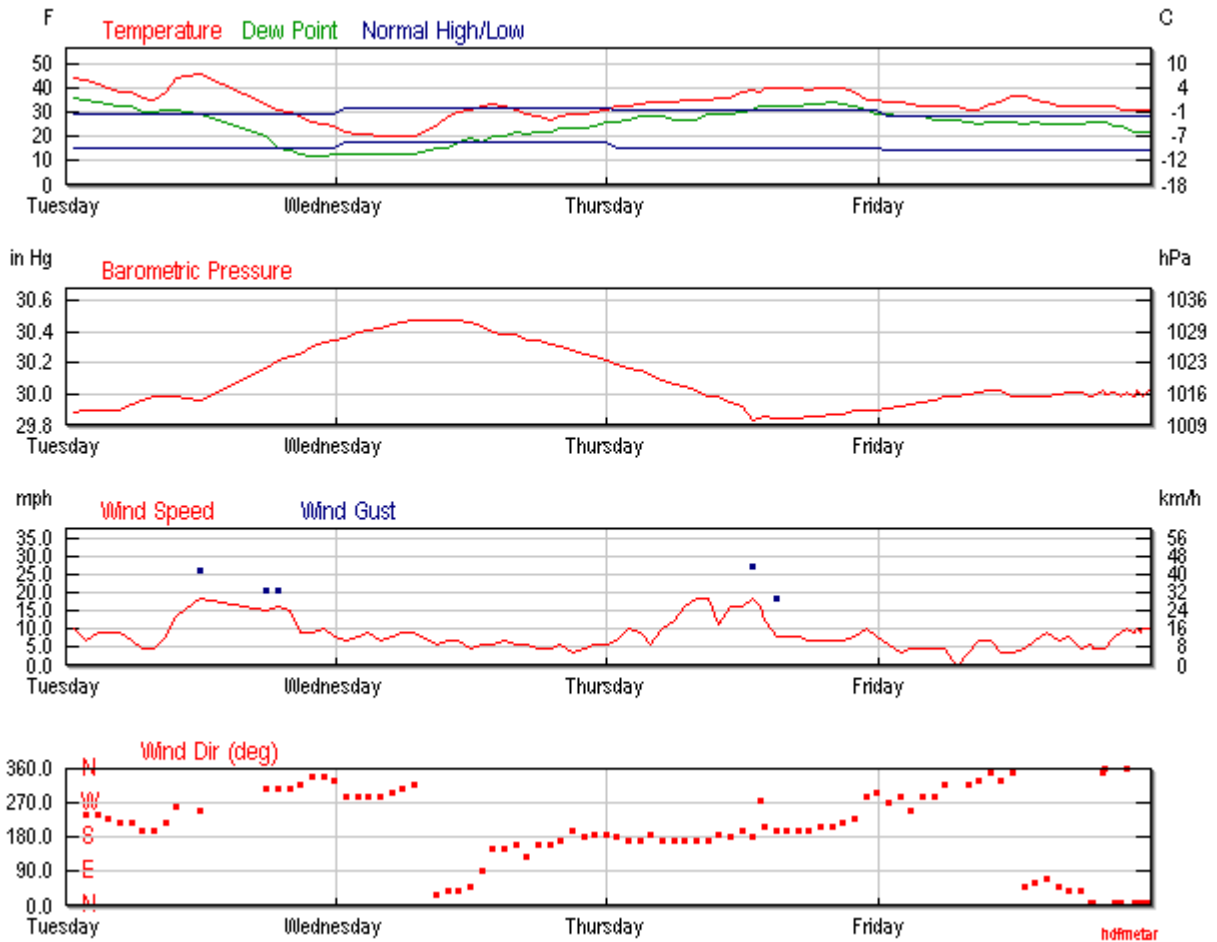

Figure 2. Chart of wind turbine rotation rates (Hz) for various wind turbine models including the Nordex N100. Note nauseogenicity range is 0.1 to 1 Hz with peak potential noted at 0.2 Hz. Note bars on GE 1.5 and Vestas V90 models indicate nominal rotation rate.

Investigations of infrasonic and low-frequency noise
 Shirley Wind Facility, Wisconsin, December 4-7, 2012

Figure 3. Weather conditions during investigations, December 4-7, 2012.



Weather source: KGRB Green Bay, WI. December 4-7, 2012

http://www.wunderground.com/history/airport/KGRB/2012/12/4/CustomHistory.html?dayend=7&monthend=12&yearend=2012&req_city=NA&req_state=NA&req_statename=NA&MR=1

Investigations of infrasonic and low-frequency noise
 Shirley Wind Facility, Wisconsin, December 4-7, 2012

Table 1. Symptom reports logged during investigations.

Date	Time	Location	Condition	Report By
12/4/2012	before 8:15 pm	R1 - Enz	Intolerable (left the home).	Mrs. Enz
12/4/2012	after 8:15 pm	R1 - Enz	Lessened. (sound levels dropped)	Rand Schomer, Rand
12/4/2012	9:30 pm	R2 – Cappelle	Dizzy, tight chest. (No sensation)	Mrs. Cappelle (Mr. Cappelle)
12/5/2012	7 am	R1 – Enz	Slept at R1. Nauseous on awakening (very unusual).	Rand
12/5/2012	11:45 am	R1 – Enz	Feel okay. WTs stopped.	Rand
12/5/2012	12::45 pm	R3 – Ashley	Feel all right. Light winds, only 2 of 8 WTs turning	Rand
12/5/2012	8:38 pm	R2 - Cappelle	Headache, left ear full.	Rand
12/5/2012	9 pm	R1 – Enz Kitchen area	Chest pain (both parties) Left ear pain "Pain of wall echoing off head."	D. Enz, D. Ashley D. Enz D. Ashley
12/5/2012	9:10 pm	R1- Enz Kitchen area	Both ears feel blocked.	Rand
12/5/2012	9:23 pm	R1 – Enz Blue bedroom	Feeling okay. Not comfortable.	Rand D. Enz, D. Ashley
12/5/2012	10:45–11:15 pm	R2 – Cappelle	Felt ill 10:45 pm, felt better around 11:15 pm. Symptoms explained- not WTs.	P. Schomer, Bruce Walker
12/5/2012	11:45 pm	R2 – Cappelle	Feeling okay except pressure in left back of head (very unusual). Stayed listening, judging condition, and observing seismometer until 12/6/12 5:30 am.	Rand
12/6/2012	1:08 pm	R2 – Cappelle	Headache onset, intensified all day (very unusual).	Rand
12/6/2012	2:06 pm	R2 – Cappelle	Pressure in back of head (very unusual, felt only at other wind turbine sites).	Rand
12/6/2012	2:55 pm	R2 – Cappelle	Very dizzy on stairs, almost fell, had to steady with hand, pressure in back of head, strong headache (very unusual).	Rand
12/7/2012	12:02 pm	R3 – Ashley	"very tolerable"; right ear popping and cracking.	D. Ashley
12/9-15/12	after testing	Maine	Dizziness, nausea persist. Eye fatigue. PC work reduced.	Rand

Investigations of infrasonic and low-frequency noise
 Shirley Wind Facility, Wisconsin, December 4-7, 2012

Table 2 (continued). Neighbor field notes.

				Enz and Ashley
Name:		Dave Enz	Location:	Homes
4-Dec	8:30 AM	Headache, tight chest, unstable at Enz home	west	4
4-Dec	3:00 PM	blurred vision, tight chest, head pressure at Enz Home	West	4-5
5-Dec	am	head and ear pressure, felt upstairs in Schmidt house from turbines dire	S-SE	1-3
5-Dec	9-10 pm	At Enz home, felt chest pain mostly on left side-it moved toward the center. It felt like my forehead was being pushed into my head, ear pressure, pain queasy stomach.	SE I think	8?
5-Dec	Midnight	At Schmidt house, head pain and ear pressure, both downstairs along east side of house where it was the worst, eyes blurry, upset stomach and unstable	SE	
6-Dec	1:00 AM	we stopped on Highview RD and videoed turbines, loud whooshing and thumping sounds varied a lot as the turbines meshed with each other.	SE	
6-Dec	1:45 AM	while laying in bed, my chest started to quiver, I checked my pulse, it seemed OK. It lasted a few minutes. Eyes are blurry and I am very unstable, I don't feel well yet.	In Denmark away from turbines	
6-Dec	8:00 AM	At Denmark House, away from turbines. Working on computer difficult due to blurry vision/eye strain. Still unstable and nauseated. I don't feel well, hope it will pass soon. Ears are still burning and sore. I don't think I will go among turbines today. I am not sure being a lab rat. Left eye seems out of touch with right eye.	In Denmark away from turbines	

				Enz Home
Name:		Rose Enz	Location:	Enz Home
Date	Time	What you were feeling	Wind direction	# turbines on
4-Dec	8:30 AM	My ears started hurting as we retrieved some items out of the house before testing	tails to the house	
4-Dec	8:45 PM	My ears started hurting and then I started side stepping as not walking in a straight line. I had a hard time not tripping over all the wires. I sat down in my rocker chair, kitchen corner for a short time, felt sick to my head and stomach.	tails to the house	

APPENDIX D
by
SCHOMER AND ASSOCIATES, INC.

December 21, 2012

I) Observations from discussions with residents:

Four of the five researchers; George Hessler, David Hessler, Bruce Walker, and Paul Schomer met with affected residents of Shirley and discussed the problems they had that were precipitated by the wind turbines. This discussion produced several notable points not previously known by this researcher.

1. At most locations where these health problems occurred, the wind turbines were generally not audible. That is, these health problems are devoid of noise problems and concomitant noise annoyance issues. The wind turbines could only be heard distinctly at one of the 3 residences examined, and they could not even be heard indoors at this one residence during high wind conditions.

2. The residents could sense when the turbines turned on and off; this was independent of hearing the turbines.

3. The residents reported "bad spots" in their homes but pointed out that these locations were as likely to be "bad" because of the time they spent at those locations, as because of the "acoustic" (inaudible) environment. The residents certainly did not report large changes from one part of their residences to another.

4. The residents reported little or no change to the effects based on any directional factors. Effects were unchanged by the orientation of the rotor with respect to the house; the house could be upwind, downwind, or crosswind of the source.

5. Residents of the nearest house reported that their baby son, now 2 years old, would wake up 4 times a night screaming. This totally stopped upon their leaving the vicinity of the wind turbines, and he now sleeps 8 hours and awakens happy.

I) Implications of these observations:

1. The fact that these residents largely report wind turbines as inaudible, and the reported effects on a baby seem to rule out the illness being caused by extreme annoyance as some have suggested.

2. The lack of change with orientation of the turbine with respect to the house and the lack of change with position in the house suggest that we are dealing with very low frequencies; frequencies where the wind turbine size is a fraction of the wavelength--about 3 Hz or lower.

II) Observations from results of measurements:

1. These observations are based upon the coherence plots and coherence graphs produced by Bruce Walker. He produced both amplitude, frequency and coherence plots and 10 minute coherence charts showing only amplitude and frequency. While both show the same thing, this analysis concentrates on the latter because the former have only a 30 dB dynamic range. Figures 1 and 2 show the coherence between the outdoor ground plane microphone and 4 indoor spaces at Residence 2: the living room, the master bedroom, behind the kitchen, and in the basement. Figure 3 shows the single valid example of basement measurements at Residence 3. The data from Residence 2 are for optimum wind conditions in terms of the turbine operation. Whereas the data at Residence 3 are for low wind conditions and not necessarily indicative of what would be found were the wind turbines operating at normal power.

2. In Implications (I), it is inferred from the resident observations that the important effects result from very low frequency infrasound, about 3 Hz or lower. We can test the assertion with the data collected at the three residences at Shirley. Only Residence 2 was tested during optimum wind conditions, so that is the primary source of data used herein. Figures 1 and 2 show the coherence

between the outdoor ground plane microphone and the four indoor spaces listed above. First, we examine Figure 1. All of the four spaces exhibit coherence at 0.7 Hz, 1.4 Hz, 2.1 Hz, 2.8 Hz and 3.5 Hz, and in this range there is no coherence indicated except for these five frequencies. The basement continues, with coherence exhibited at 4.2 Hz, 4.9 Hz, 5.6 Hz, 6.3 Hz and 7 Hz. The coherence in the basement drops low from 10-18 Hz and is more or less random and low after 18 Hz. Figure 1b shows the coherence just for the frequency range from 10 Hz to 35 Hz, and essentially this figure exhibits random patterns with no correlation from one room to the next. For example, coherence with the microphone behind the kitchen is high from 10-14 Hz and the master bedroom is high from 12-14 Hz while the other two spaces exhibit low coherence, and again the master bedroom is high 28-35 Hz with the others being low, and the living room is high from 50-58 Hz with the other spaces low; no pattern. In contrast all four spaces are lock step together in their coherence with the outdoor microphone below about 4 Hz. Figure 2, another sample from Residence 2 shows much the same pattern. In this case, 0.7 Hz, 1.4 Hz, 2.1 Hz clearly are evident for all four spaces. For some reason 2.8 Hz is much reduced for the living room but 3.5 Hz is evident for all four spaces. In terms of the basement a number of other peaks are evident up to about 8 Hz where the basement then falls low until about 18 Hz and is random thereafter. As with Figure 1, there is no pattern to the coherence function above about 8 Hz.

3. Residence 2, and indeed all three residences, exhibit classic wall resonances in about the 10-35 Hz range which are different for each room and exposure, so it is reasonable to suppose that the randomness in the 10-35 Hz region in the above ground rooms is the result of wall resonances. The basement, which has no common wall with the outside, exhibits generally the lowest coherence in the 10-35 Hz region. Thus, I conclude that the only wind turbine related data evident in the measurements at Residence 2 are the very low frequencies ranging from the blade passage frequency of 0.7 Hz to up to about 7 Hz. This conclusion is consonant with the residents' reports that the effects were similar from one space to another but a little to somewhat improved in the basement, the effects were independent of the direction of the rotor and generally not related to audible sound.

4. Figure 4 shows the coherence as functions of both time and frequency, and it is clear that the basement shows the greatest coherence below 8 Hz of the four spaces and the least coherence above 8 Hz. This result further supports the conclusion that it is the very low frequencies that are important.

5. Figure 3 is for Residence 3 which was 7000 feet from the nearest turbine, in contrast to Residence 2 which was only 1100 feet from the nearest turbine. Even here with much reduced amplitude there seems to be several frequencies where the four spaces have peaks together beginning at 0.8 Hz. However, unlike Residence 2, the coherence functions for all four of the space move together from about 15 Hz to 70 Hz. The sound pressure level at the outdoor microphone and at each of the four indoor spaces shows every harmonic from what appears to be the first harmonic at 20 Hz through 200 Hz. To my thinking this was clearly a loud outdoor source with a fundamental frequency of just under 20 Hz. And indeed it was. I called Bruce and he told me it was a helicopter. (I was not present the last day)

6. Figure 5 shows the sound pressure level for first minute of the 10 minutes represented by Figure 1, above. This figure, which is sensitive to the lowest frequencies shows that at these very low frequencies the sound pressure level in all four spaces is quite similar. The small changes from different positions in the house also suggests that the house is small compared to the wavelength so that the insides of the house are acting like a closed cavity with uniform pressure throughout being driven by very low-frequency infrasound.

II) Implications of the measurements:

1. The measurements support the hypothesis developed in (I) that the primary frequencies are very low, in the range of several tenths of a Hertz up to several Hertz. The coherence analysis shows that only the very low frequencies appear throughout the house and are clearly related to the blade

passage frequency of the turbine. As Figure 5 shows, the house is acting like a cavity and indeed at 5 Hz and below, where the wavelength is 200 Ft or greater, the house is small compared to the wavelength.

III) Observations from related literature:

1. We consider a 1987 paper entitled: Motion Sickness Symptoms and Postural Changes Following Flights in Motion-Based Flight Trainers .

This paper was motivated by Navy pilots becoming ill from using flight simulators. The problems encountered by the Navy pilots appear to be somewhat similar to those reported by the Shirley residents. This 1987 paper focused on whether the accelerations in a simulator might cause symptoms similar to those caused by motion sickness or seasickness. Figure 6 (Figure 1 from the reference) shows the advent of motion sickness in relation to frequency, acceleration level and duration of exposure. To develop these data, subjects were exposed to various frequencies, acceleration levels and exposure durations, and the Motion Sickness Incidence (MSI) was developed as the percentage of subjects who vomited. Figure 6 show two delineated regions. The lower region is for an MSI of 10%. The top end of this region is for an exposure duration of 30 minutes and the bottom end is for eight hours of exposure. The upper delineated region has the same duration limits but is for an MSI of 50%. The acceleration levels indicated for the SH3 Sea King Simulator show that the accelerations in the y and z direction went well into the nauseogenic region as defined by the Navy, whereas the P3-C Orion simulator had comparable accelerations in the x direction and lower accelerations in the y and z direction. Not surprisingly pilots' reports of sickness increased dramatically after exposure to the SH3 simulator while exposure to the P3 -C simulator had virtually no effect on reports of sickness.

2. What is important here is the range encompassed by the delineated regions of Figure 6. Essentially, this nauseogenic condition occurs below 1 Hz; above 1Hz it appears that accelerations of 1G would be required for the nauseogenic condition to manifest itself. While the Navy criteria are for acceleration, in Shirley we are dealing with pressures in a closed cavity, the house. Acceleration of the fluid filled semi-circular canal in the ear will manifest itself as force on the canal. The similarity between force on the canal from acceleration and pressure on the canal from being in a closed cavity suggest that the mechanisms and frequencies governing the nauseogenic region are very similar for both pressure and acceleration.

3. As the generated electric power of a wind turbine doubles the sound power doubles and the blade passage frequency decreases by about 1/3 of an octave. The wind turbines at Shirley have a blade passage frequency of about 0.7 Hz. This suggests that a wind turbine producing 1 MW would have a blade passage frequency of about 0.9 Hz, and on Figure 6, a change from 0.7 Hz to 0.9 Hz requires a doubling of the acceleration for the same level of response. Thus, it is very possible that this nauseogenic condition has not appeared frequently heretofore because older wind farms were built with smaller wind turbines. However, the 2 MW, 0.7Hz wind turbines clearly have moved well into the nauseogenic frequency range.

III) Implications from the Navy's Nauseogenic Criteria:

1. This analysis suggests that similar problems to the problems in Shirley can be expected for other wind turbines that have the same or lower fundamental frequency. The Navy criteria suggests that to maintain the same level of health-related effects as have occurred heretofore, the levels of a 2 MW, 0.7 Hz wind turbine as experienced in the community must be 6 dB lower than those for 1 MW, 0.9 Hz wind turbine. Moreover, Figure 6 does not bode well for future larger wind turbines if they go even lower in frequency.

IV) Descriptors for Wind Turbine Emissions

1. Currently the wind turbine industry presents only A-weighted octave band data down to 31 Hz. They have stated that the wind turbines do not produce low frequency sound energies. The

measurements at Shirley have clearly shown that low frequency infrasound is clearly present and relevant. A-weighting is totally inadequate and inappropriate for description of this infrasound. In point of fact, the A-weighting, and also the C and Z-weightings for a Type 1 sound level meter have a lower tolerance limit of -4.5 dB in the 16 Hz one-third-octave band, a tolerance of minus infinity in the 12.5 Hz and 10 Hz one-third- octave bands, and are totally undefined below the 10 Hz one-third-octave band. Thus, the International Electro-technical Commission (IEC) standard needs to include both infrasonic measurements and a standard for the instrument by which they are measured.

V) The Tests We Should Perform

1. That the wind turbines make people sick is difficult to prove or disprove. However, the sensing of the turbines turning on or off is testable. Consider the two houses where there is no audible sound. Residents would arrive at the house with the wind turbines running for something like a 2-hour test. Sometime during the first hour, the wind turbines might or might not be turned off. If turned off, it would be the residents task to sense this "turn off" within some reasonable time--say 1 hour. Correct responses (hits) would be sensing a "turn off" when the turbines were turned off, or sensing no change if they were not turned off. Incorrect responses (misses) would be failure to sense a turn off when the turbines were turned off, or "sensing" a turn off when the turbines were not turned off. Similar tests could be done starting with the turbines initially off.

2. It would be necessary to prevent the subjects from seeing the turbines or being influenced by one another. If everyone marked a silent response on their board or into their laptop at the same time; say every 5 minutes, then no one would be able to know another person's responses. Pure chance is 50/50, so a hit rate statistically significantly greater than 50/50, and/or a miss rate statistically significantly less than 50/50 would indicate that the residents were able to sense the wind turbines without the use of sight or sound.

3. Testing would take about 3 to 5 good days; days when the wind was such that the wind turbines were operating at a substantial fraction of full power. Up to 3 tests per day could be done, with 3-4 subjects in each of the two, or possibly 3, houses. Physical measurements would be made of the before and after conditions at each house simultaneously to correlate with the sensing tests. Each subject would be tested up to 5 times. Note: Testing multiple times per day presupposing that the subjects could tolerate such a rigorous testing schedule.

4. The testing would require at least 1 researcher at each house to take the physical measurements and one researcher to supervise the sensing test with one test "proctor" per test room. It would be necessary for the proctor to help the researcher performing the physical measurements during non-test hours with activities like calibration.

5. Conduct of this test clearly requires the assistance and cooperation of Duke Energy. This test can only be done if Duke Energy turns on and off the turbines from full power, as requested and for the length of time requested.

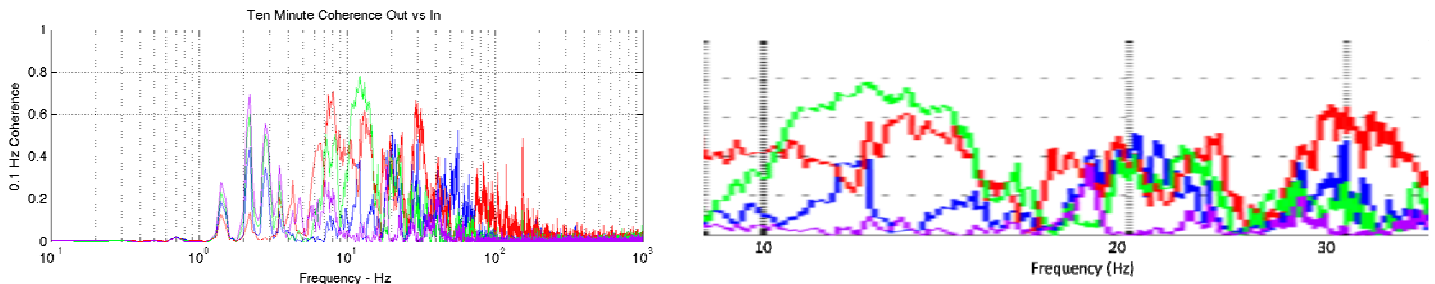

Figure 1a, b: R2-5T212420--coherence with outdoor-ground plane microphone; Living Room-Blue, Master Bed Room- Red, Behind Kitchen- Green, Basement-Purple, b is an expanded view from 9 Hz to 35 Hz

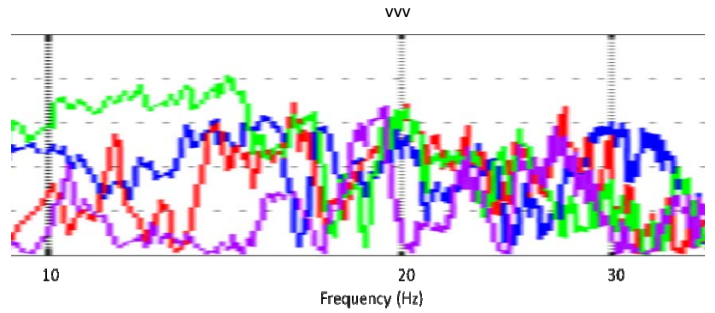
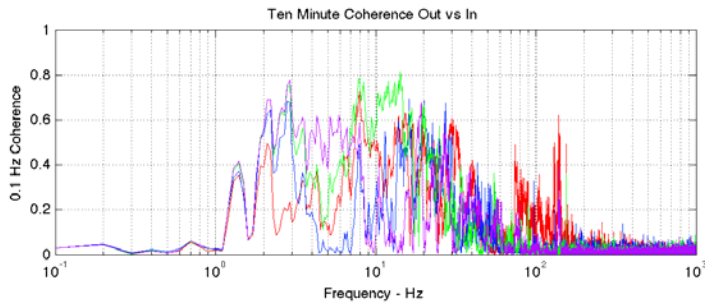

Figure 2a, b: R2-5T204657--coherence with outdoor, ground-plane microphone; Living Room-Blue, Master Bed Room-Red, Behind Kitchen- Green, Basement-Purple, b is an expanded view from 9 Hz to 35 Hz

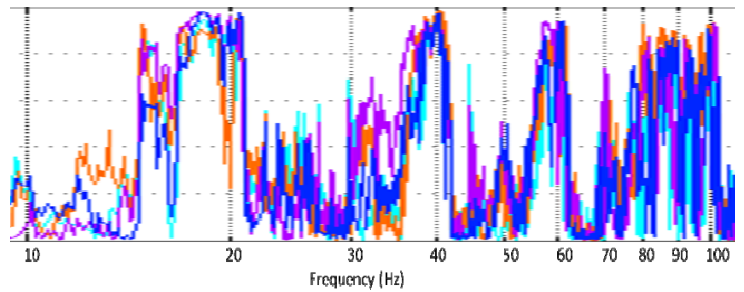
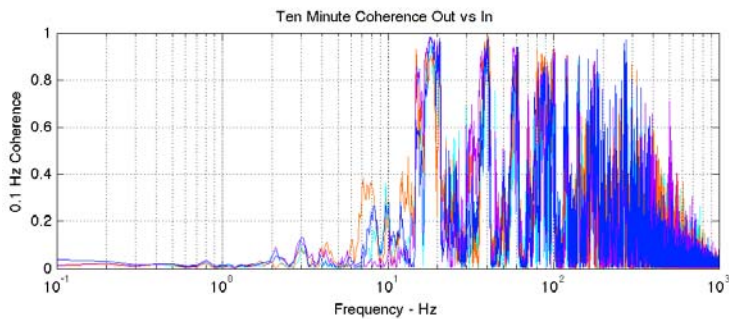
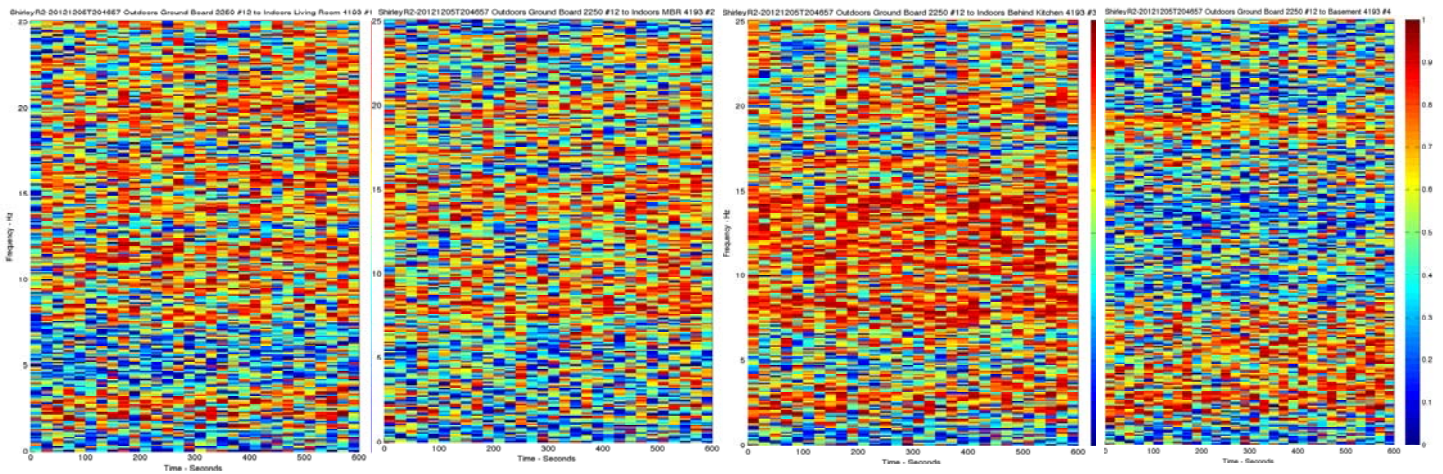

Figure 3a, b: R2-5T204657; Living Room-Blue, Upstairs Bed Room- Orange, Family Room- Turquoise, Basement-Purple, b is an expanded view from 10 Hz to 100 Hz. Note the strong coherence from 20 through at least 80 Hz that resulted from a nearby Helicopter.



4a- Living Room

4b- Master Bed Room

4c- Behind Kitchen

4d- Basement

Figure 4a,b,c,d- Coherence with the outside ground microphone and the four inside microphones in the locations indicated. Note the Basement (4d) which does not have walls coincident with outside shows high coherence at the wind turbine blade passage frequency for several harmonics and almost no coherence above about 8 Hz where the at or above ground walls are resonant.

5

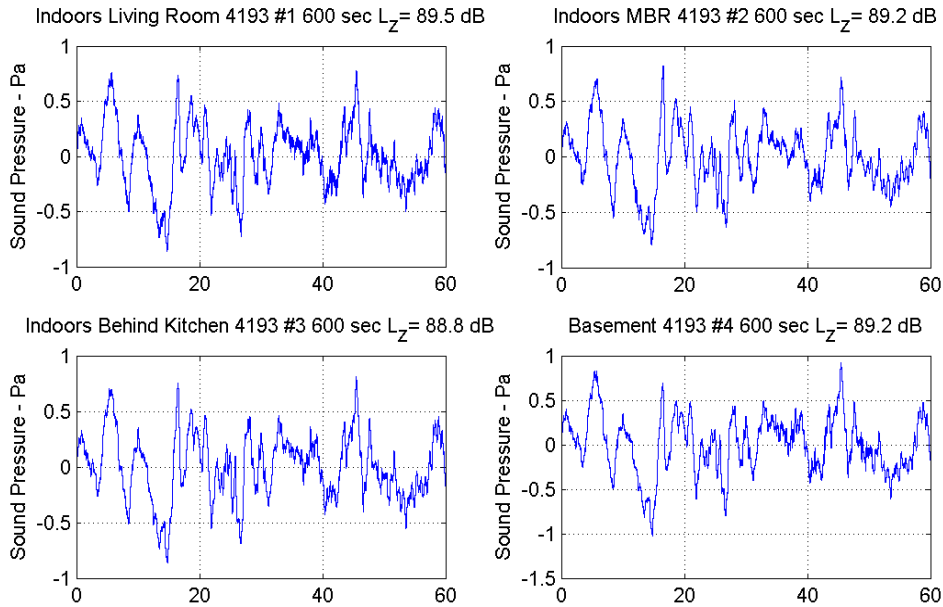

Figure 5- First of the ten minute period of 5T212420. Note that the SPL is very similar for all indoor locations.

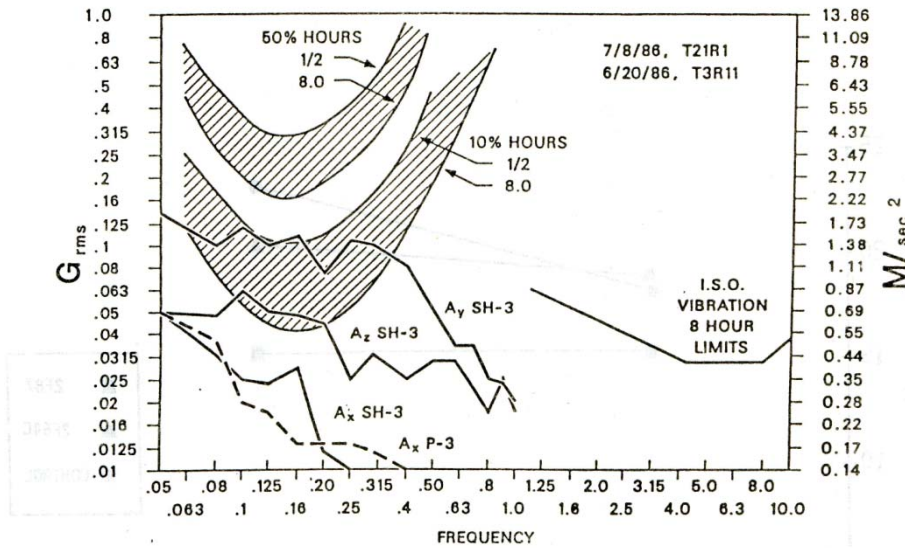

Figure 6. SH3 Sea King Nominal Run vs P-S Orion Nominal A_x

Figure 1 from "Motion Sickness Symptoms and Postural Changes Following Flights in Motion-Based Flight Trainers"

R.S. Kennedy, G.O. Allgood, B.W. Van Hoy, M.G. Lilienthal, (1987). " Motion Sickness Symptoms and Postural Changes Following Flights in Motion-Based Flight Trainers," Journal of Low Frequency Noise and Vibration, 6 (4), 147-154.